

MYSTERY
RANCH®

MYSTERY RANCH's
Brand Ambassador
Lindsay Browne Davis
Photo: Jay Beyer

FALL 2023

HUNT WORKBOOK

BACKPACK HUNTING PACKS | 6 - 14

BAG ONLY | 16 - 17

EXTENDED DAYPACKS | 18 - 21

WHITETAIL PACKS | 22 - 27

WATERPROOF | 28 - 35

DAYPACKS | 36 - 41

EVERYDAY CARRY | 42 - 59

TRAVEL | 60 - 65

ACCESSORIES | 66 - 79

LOGOWEAR | 80 - 83

FITTING & SIZING | 84 - 85



BUILT FOR
THE
MISSION®

For much of the past 20 years, we've developed Load Carriage™ systems for the most demanding customers and environments out there: military combat and wildland firefighting. These high-level users came to us because they knew of our pack-engineering pedigree. They needed purpose-built packs that would carry monstrous loads with more stability — packs that would endure relentless hammering in the field without failure... year in and year out. Designing for this professional and industrial user has taught us about building functional, comfortable packs for hikers, backpackers, climbers, skiers, hunters, and other outdoor zealots.

With a heritage rooted in mountain sports, we're psyched to come full circle. Our goal is to partner with outdoor specialty shops whose customers demand the most evolved, proven, load-bearing designs. With so much commodity product on the market, MYSTERY RANCH packs distinguish themselves with active suspension systems and only the highest quality durable fabric and trim packages. Designed and built to endure the long haul—and then some.

MYSTERY RANCH® — BUILT FOR THE MISSION®

WARRANTY & REPAIRS



MYSTERY RANCH designs and manufactures packs for the job that needs to get done, supporting customers who rely on our packs to get home at the end of the day. Our Warranty guarantees everything we build against defects in materials and craftsmanship for the practical lifetime of the product. We will happily offer repair or replacement for issues with materials or craftsmanship. Damage due to normal wear and tear or misuse can be repaired for a reasonable charge.

PATENTS

Most MYSTERY RANCH products are covered by US and Foreign Patents, and other Patents Pending.

US Patents include:

US 6,626,342 B1; US 7,673,777 B2; US 8,381,956 B2; US 8,561,866 B2; US 8,950,644 B2; US 8,348,114 B2; US 8,579,171 B2; US 9,173,473 B2; US 9,271,559 B2; US 8,162,194 B2 ; US 8,955,792 B2

CERTIFICATIONS

MYSTERY RANCH maintains an ISO 9001:2015 Quality Management System.

MATERIALS & TECHNOLOGY

CORDURA®

CORDURA® fabrics

YKK®

YKK® Zippers

**FUTURA
YOKE**

FUTURA YOKE SYSTEM

The patented MYSTERY RANCH Futura Yoke system enables you to micro-adjust the torso length, making it a crucial piece of the pack's structure.

**OVERLOAD®
FEATURE**

OVERLOAD® FEATURE

The patented OVERLOAD® feature provides functional expandability via a load sling between the pack and the frame, allowing you to put the bulk of the weight closest to your back for optimal comfort.

**GUIDE LIGHT MT™
FRAME**

GUIDE LIGHT MT™ FRAME

The patented GUIDE LIGHT MT™ FRAME continues the load carriage tradition with its rigid yet dynamic frame system. Utilizing custom-developed SJ Autolock buckles and 500D Light Plus CORDURA® fabric in combination with the five-point waistbelt, this frame delivers strength and durability regardless of the load.



BACKPACK HUNTING PACKS

Whether you're hopping on a bush plane for a 10-day sheep hunt or doing a day hunt in the back forty, these packs are your solution.

These packs are designed for the hunter needing to keep their gear clean, dry, and organized. The OVERLOAD® feature remains at the ready for the real work: hauling game out of the wilderness.

ENDURE THE PURSUIT.



The GUIDE LIGHT MT™ FRAME continues the load carriage tradition of the tried-and-true GUIDE LIGHT™ FRAME and its rigid yet dynamic frame system—but with a few discreet changes. Utilizing custom-developed SJ Autolock buckles throughout the attachment points, this new hardware collection provides the perfect blend of strength and weight. The 500D Light Plus CORDURA® fabric delivers high tensile and tear resistance — key characteristics for a robust, purpose-driven hunting frame. Additionally, the five-point waist belt incorporates the highly functional Redirect System, which delivers solid weight distribution and eliminates slippage over your hips, regardless of the load.

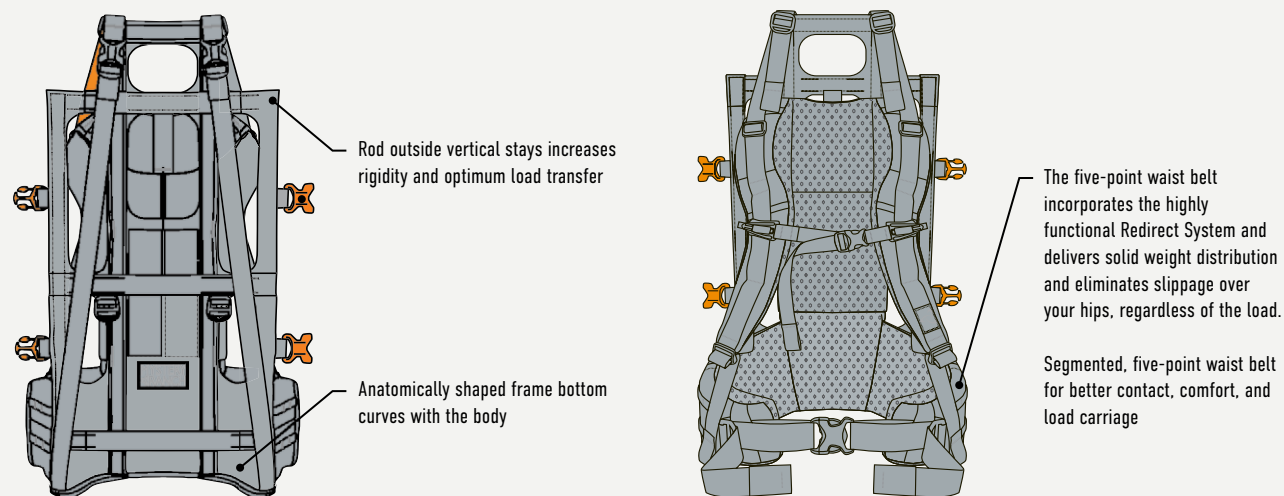

READY FOR THE PACK OUT.



Functional expandability — via the patented OVERLOAD® feature — is designed into select MYSTERY RANCH hunting packs. This key feature allows you to put the bulk of the weight closest to your back for optimal pack out comfort. With added length to the compression straps, you can easily place meat/quarters between the pack and the frame and secure it with the auto-locking buckles for a load that won't loosen over time.

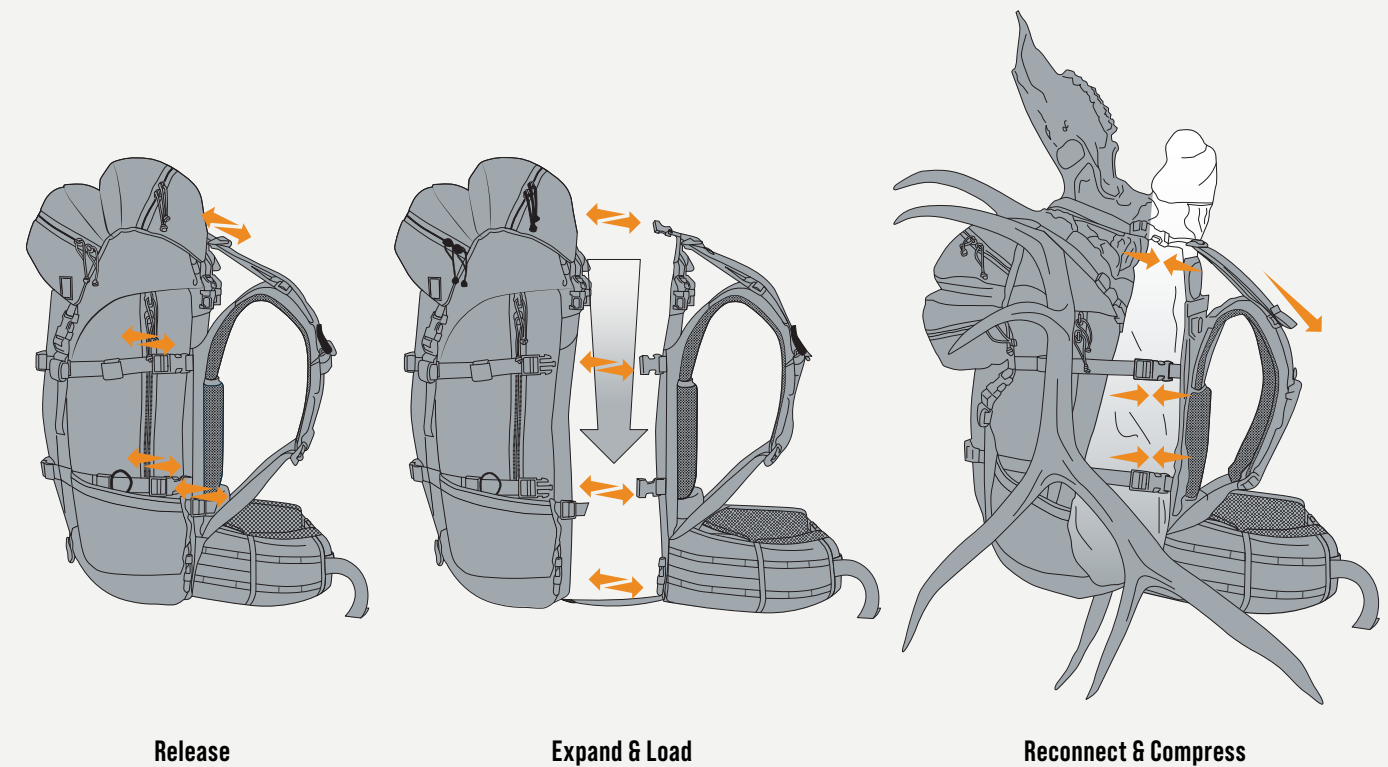

MARSHALL

Like its namesake – the Bob Marshall Wilderness – this pack is expansive, with accessibility via a top-load shroud and full-length, dual-side zips. Two additional long pockets and a sleeping bag compartment make this pack perfect for any expedition.

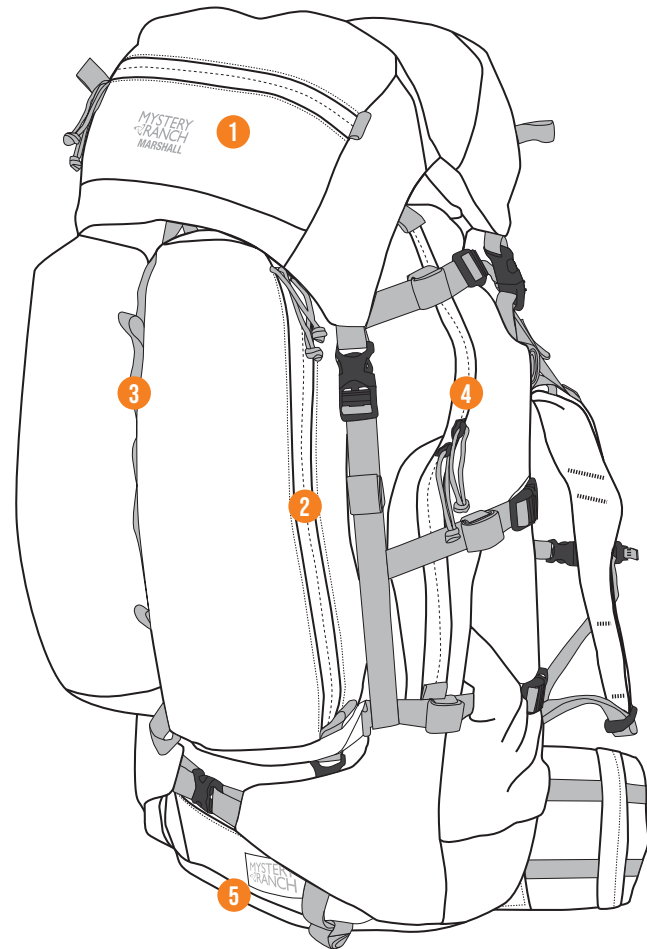

KEY FEATURES:

- 1 Removable Daypack Lid with shoulder straps
 - 2 Two external long pockets for rapid access are sized for spotting scopes
 - 3 Daisy chain for attaching accessories
 - 4 Side zip for easy access to main bag
 - 5 Speedzip™ compartment for easy access to sleeping bag
- Includes Quick Attach Accessory Straps for bow or rifle carry



SPECS:

Weight: 3.4 kg (7.5 lbs)
 Vol: 105 L (6405 cu-in)
 Sizes: S M L XL



Foliage



Subalpine

BEARTOOTH 80

The unique 270° “duffel-style” zipper opening offers easy access no matter how it’s packed – from top, side, or bottom. Multiple pockets, both outside and on the main opening’s inside flap, keep all the essentials close at hand.



KEY FEATURES:

- 1 Removable lid with zippered pockets
 - 2 Zippered face pocket
 - 3 270° “duffel-style” access
 - 4 Side water bottle, rifle, or tripod pockets
- Compatible with Quick Attach Accessory Straps for bow or rifle, carry



Bag Only Option pg. 17

SPECS:

Weight: 2.9 kg (6.4 lbs)
 Vol: 85 L (5185 cu-in)
 Sizes: S M L XL



Coyote



Foliage



Subalpine

METCALF

This versatile workhorse has enough volume for a week in the field but is compressible enough for an afternoon stalk. This top-loading pack is a favorite among hunters looking for flexibility and all-around utility.



KEY FEATURES:

- 1 Removable lid that converts to a daypack with shoulder pads
- 2 Bow and rifle carry via compression straps
- 3 Side zip for easy access to main bag
- 4 Side water bottle, rifle, or tripod pockets
 - Interior removable Quick Attach Zoid Bag attachment points



GUIDE LIGHT MT[™]
FRAME

OVERLOAD[®]
FEATURE

SPECS:

MEN'S

Weight: 2.7 kg (6 lbs)
Vol: 71 L (4335 cu-in)
Size: S M L XL

WOMEN'S

Weight: 2.7 kg (6 lbs)
Vol: 71 L (4335 cu-in)
Sizes: XS S M L



Coyote



Foliage



Subalpine

SAWTOOTH 45

This 45-liter low-profile pack is ingenious with organization and hits the mark for backcountry hunters. The 270° “duffel-style” zipper opening allows for effortless access and is roomy enough for a fast and light overnighter or dawn-til-dusk hunts.

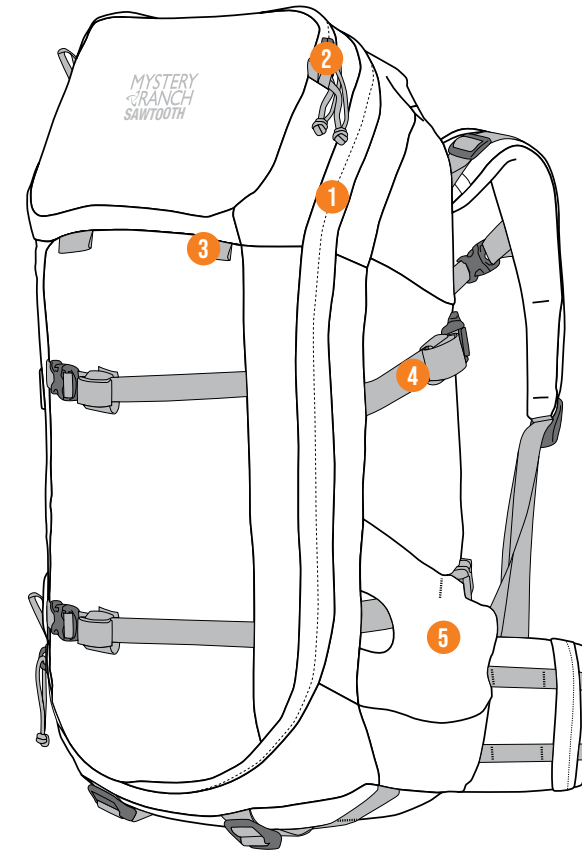

KEY FEATURES:

- 1 270° “duffel-style” zipper access
- 2 Zippered lid pocket with two inner zipper pockets on inside of opening flap
- 3 Compatible with Quick Attach Accessory Straps for bow or rifle carry
- 4 Compression loops for tripod or trekking pole carry
- 5 Side water bottle, rifle, or tripod pockets
 - Four internal pockets for organization
 - Compatible with Hunting Daypack Lid

GUIDE LIGHT MT[™]
FRAME

OVERLOAD[®]
FEATURE

SPECS:

Weight: 2.3 kg (5.18 lbs)
Vol: 45 L (2745 cu-in)
Sizes: S M L XL



Coyote



Foliage



Subalpine

PINTLER

The PINTLER is the perfect streamlined pack that provides numerous internal pockets for easy organization in a low-profile package. The addition of the OVERLOAD® feature is the secret weapon for the long pack out.

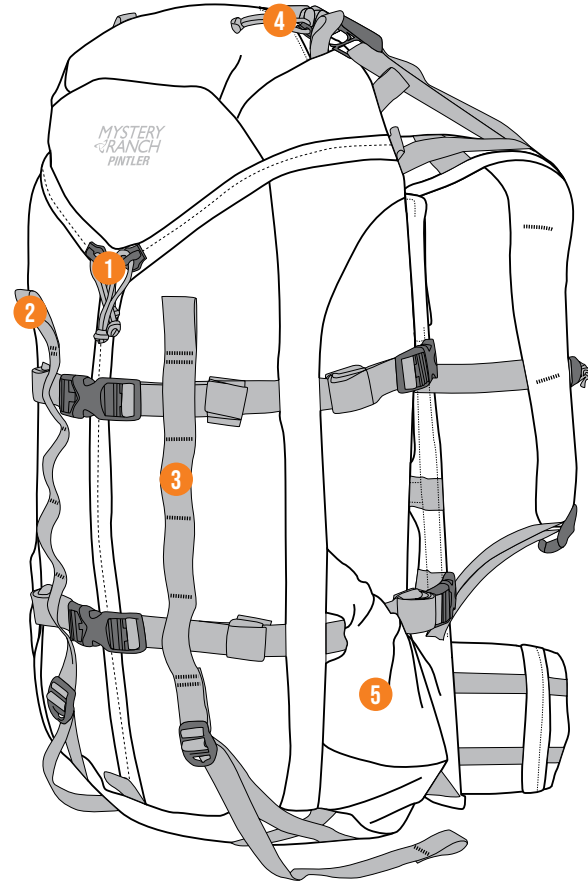

KEY FEATURES:

- 1 3-ZIP design for rapid and complete access to gear
- 2 Compatible with Quick Attach Accessory Straps for bow or rifle carry
- 3 Daisy chain for attaching accessories
- 4 Zippered lid pocket with two internal pockets
- 5 Side water bottle, rifle, or tripod pockets
 - Two internal dump pockets and four internal zip pockets
 - Compatible with Hunting Daypack Lid

 **GUIDE LIGHT MT™**
FRAME

 **OVERLOAD™**
FEATURE

Bag Only Option pg. 17



Coyote



Foliage



Subalpine

SPECS:

Weight: 2.6 kg (5.7 lbs)

Vol: 38.6 L (2355 cu-in)

Sizes: S M L XL

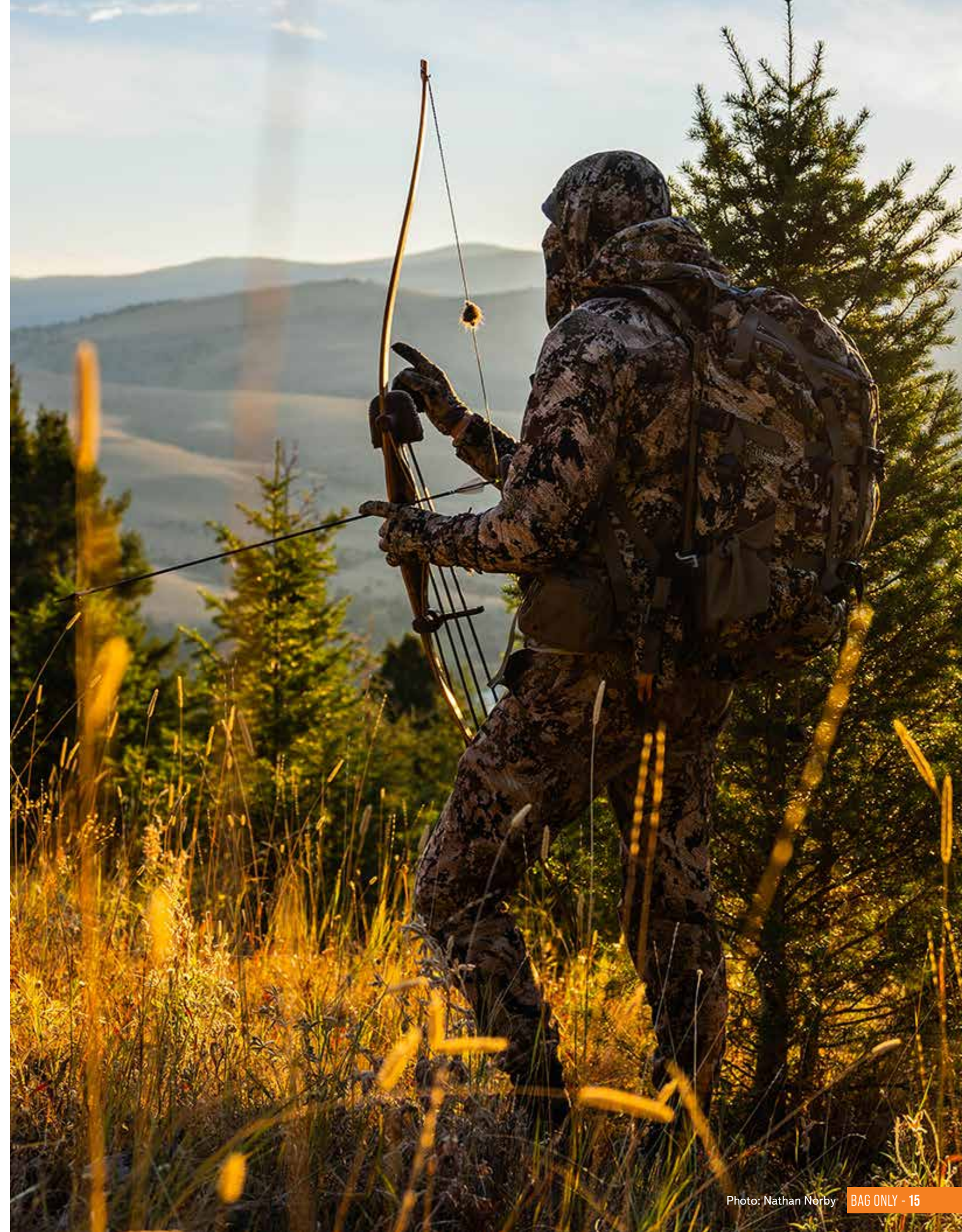

MULE - BAG ONLY

For those who already have a **GUIDE LIGHT MT™ FRAME**, the **MULE** is a 23 L pack sack that attaches to create a workhorse hybrid for multiple hunting applications. Whether packing in or packing out, the **MULE** is a versatile load sling for hauling your overnight camp kit or retrieving meat.

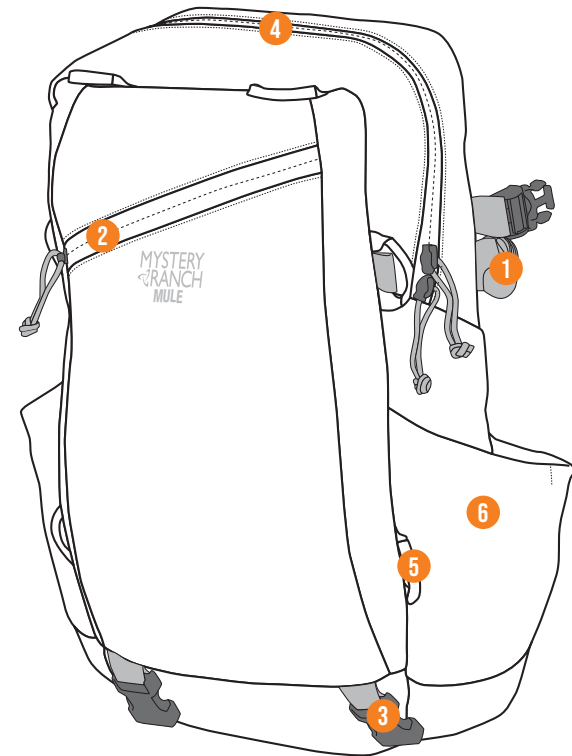

KEY FEATURES:

- 1 OVERLOAD® sling to attach to frame
 - 2 Zippered pocket on face of bag
 - 3 Bottom and side compression straps
 - 4 Top-zip access to main compartment
 - 5 Compatible with Quick Attach Accessory Straps for bow or rifle carry
 - 6 Side pockets for water bottle, rifle, or tripod
- Hydration-compatible



Coyote

Foliage

Subalpine

SPECS:

Weight: 0.6 kg (1.3 lb)
Vol: 23 L (1405 cu-in)
Sizes: One Size

DIVERSIFY YOUR HUNTS.

BAG ONLY OPTIONS

For those who already own a **GUIDE LIGHT MT™ FRAME**, having the opportunity to quickly switch pack bags is key. **MYSTERY RANCH** Bag Only Options deliver hassle-free, mission-specific solutions for any hunt.

For fast and light day hunts where only the essentials are needed, the **MULE** has got your back. For longer day hunts or a quick overnighter, get ready to party with the **PINTLER**. And for those big game adventures spanning a week or more, the **BEARTOOTH 80** is your huckleberry. All bag only options have the **OVERLOAD®** feature for the pack out.

Available in:

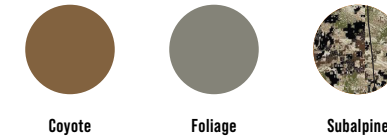

Coyote

Foliage

Subalpine

BEARTOOTH 80*

*Beartooth Bag Only, not available in Coyote.

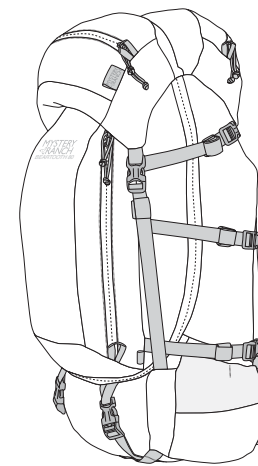

Weight: 1.5 kg (3.3 lbs)
Vol: 85 L (5185 cu-in)

Full Pack Details pg. 11

PINTLER

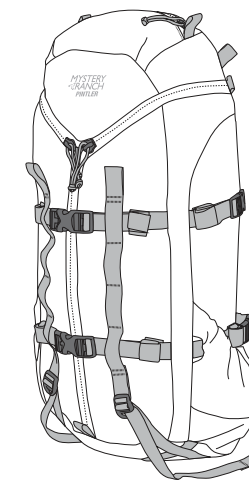

Weight: 1 kg (2.2 lbs)
Vol: 38.6 L (2355 cu-in)

Full Pack Details pg. 14

MULE



Weight: .6 kg (1.3 lb)
Vol: 23 L (1405 cu-in)

Full Pack Details pg. 16



BRINGING HOME THE MEAT.

POP-UP FRAME

The POP-UP FRAME feature converts this daypack into a load-hauling system. For those shorter, successful dayhunts, shouldering out the brutal weight necessary for extraction is a necessity. This function allows the frame to easily expand and adjust to carry loads up to 80 lbs. It features expandable pole stays and the OVERLOAD® feature.

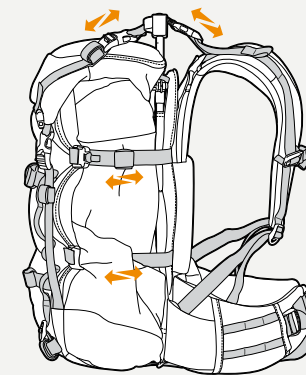

Unbuckle & Loosen

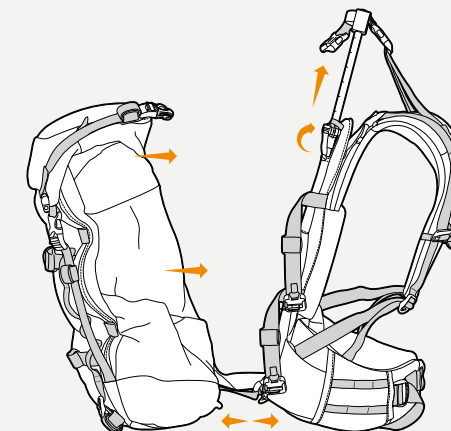

Flip Locking Mechanism,
Extend Frame & Lock

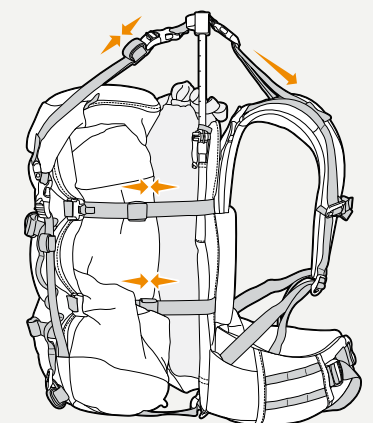

Reconnect & Compress

POP UP 30

A new generation hunting pack that stays low-profile and functional during your hunt but transforms into a bona fide meat hauler when you need to do some serious lifting.

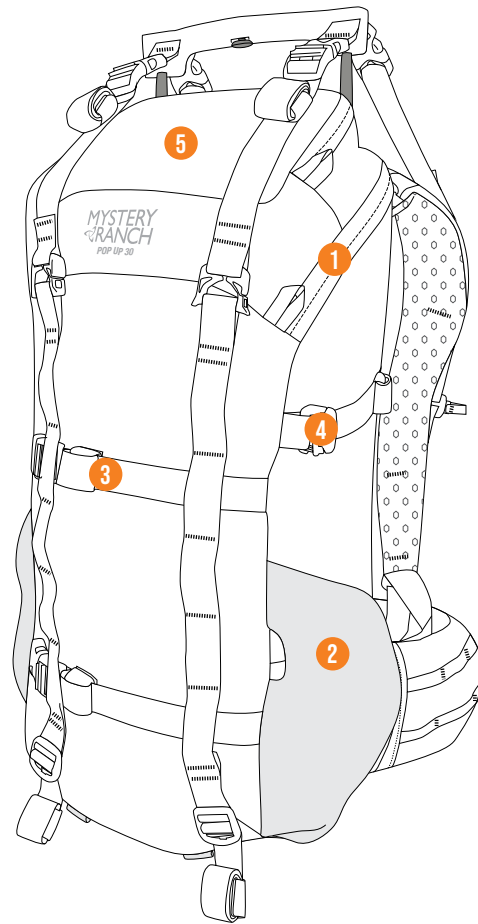

KEY FEATURES:

- 1 Access to the interior via the horseshoe main zipper
- 2 Dual stretch-woven side pockets for water bottle or trekking poles
- 3 Face compression can be used to securely carry a bow or rifle
- 4 Side compression with locking gatekeeper hooks keep webbing secure and in place
- 5 Lid with pocket for additional organization
 - Attach loops on the body panel for MYSTERY RANCH Small Quick Attach Zoid Bag
 - Integrated 1/4" - 20 optics thumbscrew on frame allows you to thread your camera, spotting scope, or rifle mount directly to the frame for optimal stabilization



SPECS:

MEN'S

Weight: 2.2 kg (4.9 lbs)
 Vol: 30 L (1830 cu-in)
 Sizes: S M L XL

WOMEN'S

Weight: 2.2 kg (4.9 lbs)
 Vol: 30 L (1830 cu-in)
 Sizes: XS S M L



POP UP 40

For those wanting a higher-volume daypack that stays low-profile and functional during your hunt, the POP UP 40 stands ready – and it has the chops to shoulder some serious load lifting to boot.

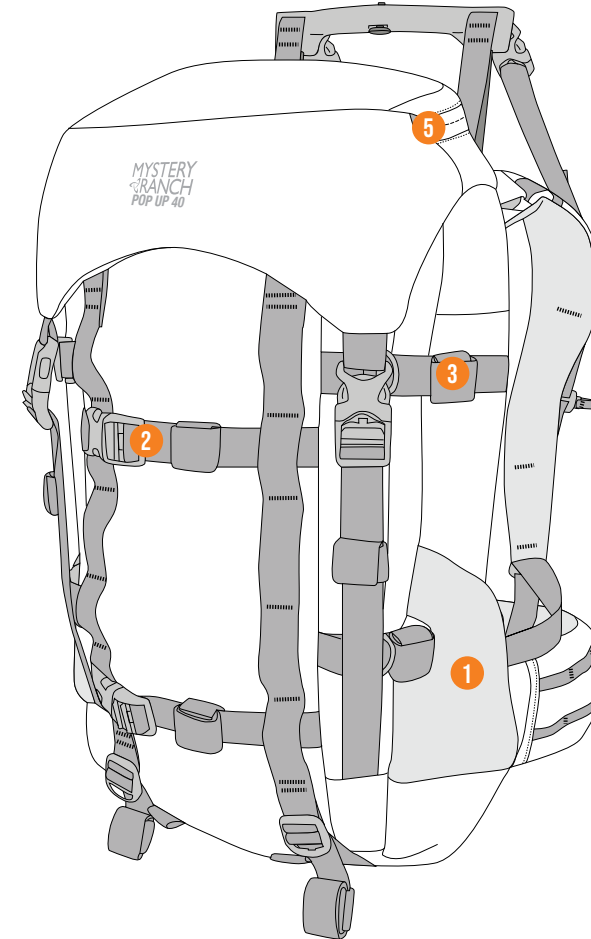

KEY FEATURES:

- 1 Dual stretch-woven side pockets for water bottle or trekking poles
- 2 Face compression can be used to carry a bow or rifle
- 3 Gatekeeper hooks keep compression webbing secure and in place
- 4 Attach loops on the side and interior body panel for MYSTERY RANCH Quick Attach Zoid Bags
- 5 Adjustable, removable lid with pocket
 - Easy access to interior with top-load and full-side zipper access and drawstring shroud
 - Integrated 1/4" - 20 optics thumbscrew on frame allows you to thread your camera, spotting scope, or rifle mount directly to the frame for optimal stabilization



SPECS:

Weight: 2.4 kg (5.3 lbs)
 Vol: 40 L (2440 cu-in)
 Sizes: S M L XL

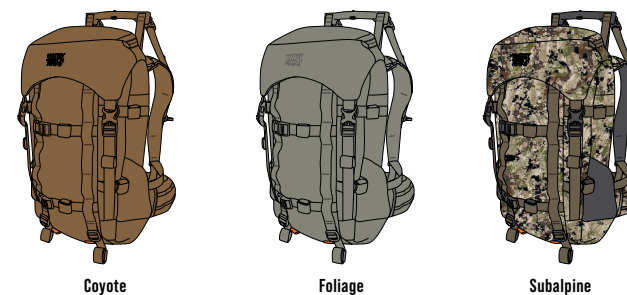

WHITETAIL

These packs are the standard for whitetail pursuits.

With user-tested layout and features, tree stand hunters and whitetail fanatics alike will appreciate the TREEHOUSE backpacks. Available in two different capacities, they are built with durable, water-resistant, hyper-quiet fabrics.

NEW

TREEHOUSE 9

When stealth and maneuverability are of utmost importance, the TREEHOUSE 9 is the minimalist hip pack you can trust to be at your side.

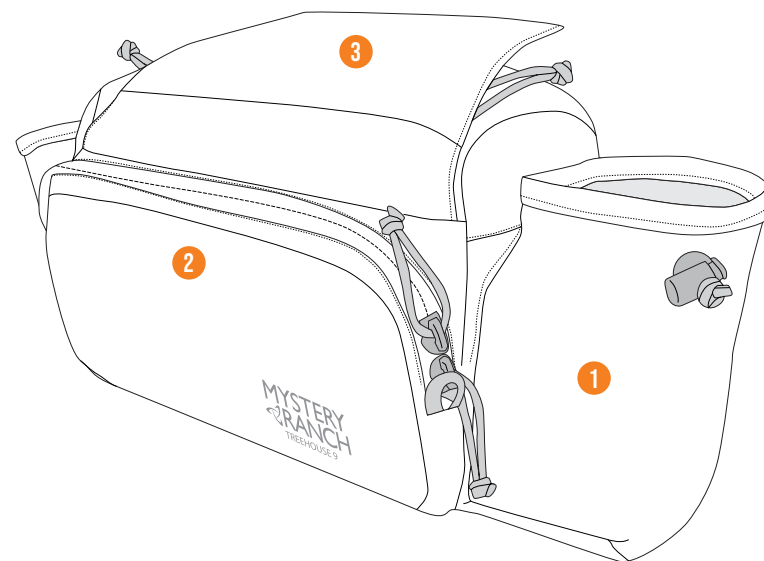

KEY FEATURES:

- 1 Two side pockets with elastic pull cords for securing water bottles, handheld archery releases, calls, and ammunition
 - 2 Front zippered pocket with organizational detail pockets
 - 3 Main opening is a magnetic rip zip top flap for quick and easy access
- Top Rip Zip lid has a mesh pocket on the inside for go-to items
 - Variety of internal organization pockets inside the bag - one zippered mesh pocket and three small detail pockets
 - Lashing straps on the bottom of the bag for extra layers or other items
 - Comes kitted with removable Trail Wrap pocketed waist belt
 - Shoulder strap attach points on the top of the body panel allow for dual carry modes
 - Super quiet, custom-designed fuzzy polyester backed with Nylon 210D laminate fabric and 640 Cotna for a quiet internal fabric for extra stealth



Wood



DPM Canopy

SPECS:

Weight: 1.6 kg (3.54 lbs)
 Vol: 9 L (545 cu-in)
 Sizes: XS/S S/M L/XL

NEW

TREEHOUSE 16

When stealth and speed are of utmost importance, the TREEHOUSE 16 is the light yet feature-packed bag you can trust to have your back on day hunts.

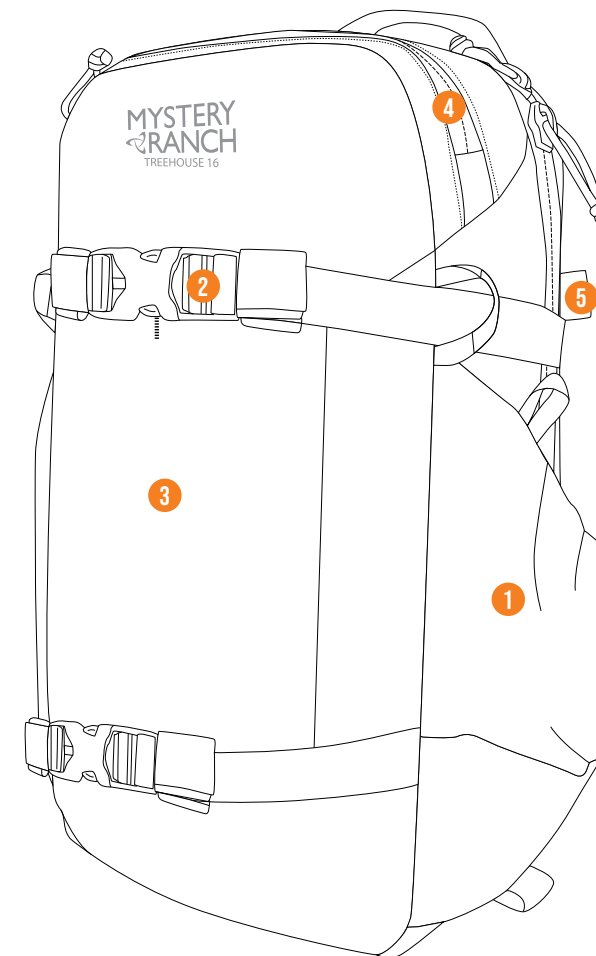

KEY FEATURES:

- 1 Two stretch fabric water bottle pockets
 - 2 Dual compression straps on the face of the bag for a bow, climbing sticks or rattling antlers
 - 3 Stretch pocket on the front of the bag for layers or extra gear
 - 4 Clam shell opening into bag offers easy access
 - 5 Includes quick-attach strap for attaching to a tree when in your stand or ground blind.
- Fixed harnessing
 - Super quiet, custom-designed fuzzy polyester backed with Nylon 210D laminate fabric and 640 Cotna for a quiet internal fabric for extra stealth
 - External zippered mesh detail pocket
 - Internal zippered mesh pocket on the body panel for extra gear
 - Inner dump pocket is hydration compatible



Wood



DPM Canopy

SPECS:

Weight: 1.17 kg (2.6 lbs)
 Vol: 16 L (975 cu-in)
 Sizes: One Size

TREEHOUSE 20

When your mission is a quick run and gun, hunting from above with the TREEHOUSE 20 is the only pack you'll need.

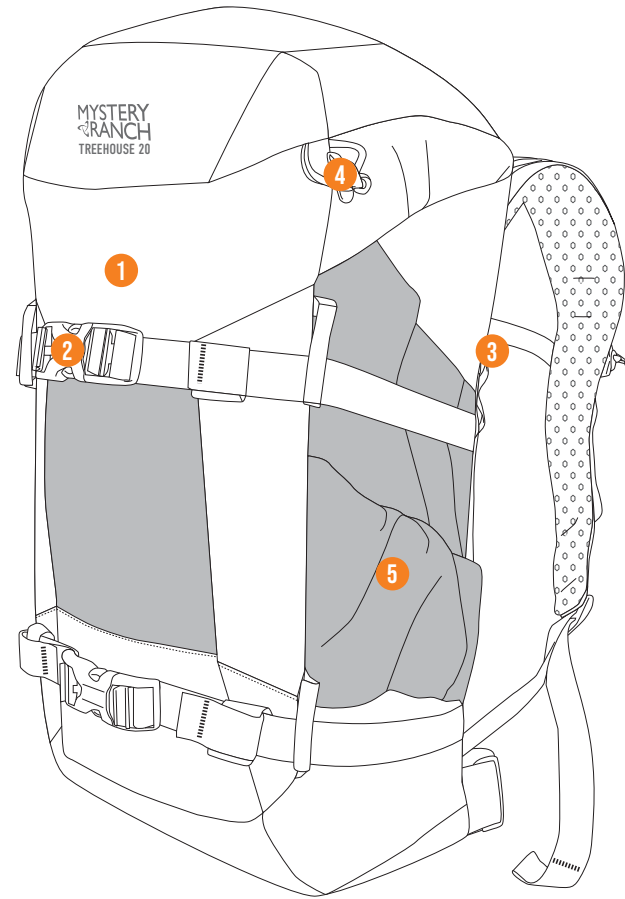

KEY FEATURES:

- 1 Wildly durable, water-resistant and wilderness quiet - the unique custom-designed fuzzy polyester backed with Nylon 210D laminate fabric keeps the focus off of you
- 2 Bow or stand carry capable via full side compression straps and pass-through guide loops
- 3 No more hanging for a hook! The removable tree straps and top haul loop are designed for secure and easy attachment to trees.
- 4 Silent external shock cord secures rattling antlers for the hike in
- 5 Ample organization with multiple stretch pockets both inside and out, and additional organizational workspace in the lid for easy access to essential tools while pack is open
 - Internal cinch pockets with silent closures and additional workspace in the lid provide ample organization so your gear and snacks have their place



Wood



DPM Canopy

SPECS:

Weight: 1.3 kg (2.8 lbs)
Vol: 20.9 L (1275 cu-in)
Sizes: One Size

TREEHOUSE 38

Long days and long distance call for more gear, and the TREEHOUSE 38 will carry all of it—including the stand—without breaking your back.

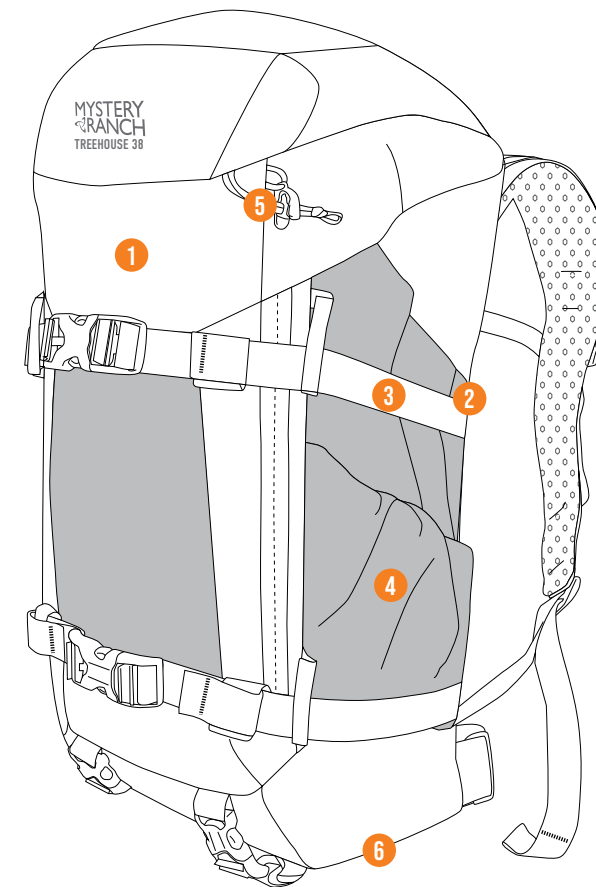

KEY FEATURES:

- 1 Wildly durable, water-resistant, and wilderness quiet - the unique custom-designed fuzzy polyester backed with Nylon 210D laminate fabric keeps the focus off of you
- 2 No more hanging from a hook! The removable tree straps and top haul loop are designed for secure and easy attachment to trees
- 3 Full side compression straps and pass-through guide loops secure your bow or treestand to the pack so you don't have to carry with your hands
- 4 Ample organization with multiple stretch pockets both inside and out, and additional organizational workspace in the lid for easy access to essential tools when pack is opened
- 5 Silent external shock cord secures rattling antlers for the hike in
- 6 Squared off bottom allows pack to stand up on its own



Wood



DPM Canopy

SPECS:

Weight: 2.0 kg (4.5 lbs)
Vol: 38 L (2370 cu-in)
Sizes: S M L XL

WATERPROOF

**Built for the Mission also means
withstanding the elements. This
innovative series is designed to be
your multi-use, water-tight solution.**

Pairing TRU Zip Waterproof zippers with MYSTERY RANCH's ingenious construction method and materials, this collection of packs will tolerate the most extreme elements — hail, rain, or shine.

HIGH WATER SERIES

TECH

Built with 840D ballistic nylon with double-sided TPU coating for waterproofness, high-abrasion & tear resistance, high-temp resistance, and low-temp flexibility

TRU® Zip is the first-ever sliding, toothless, silent, dust-proof, waterproof submersible, self-healing complete zipper assembly

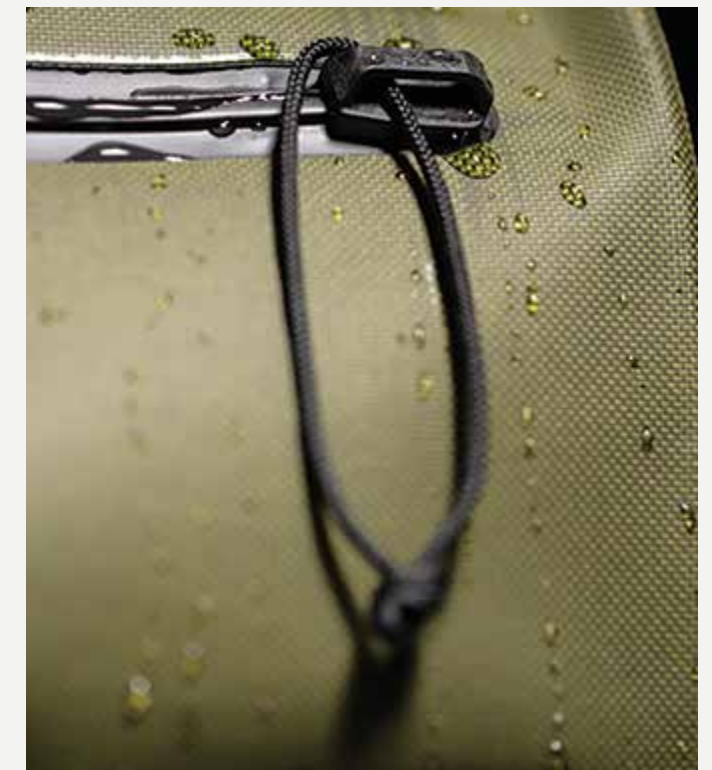

HIGH WATER DUFFEL

This duffel is ready for any adventure. Designed to fit perfectly on the OVERLOAD® feature of the TERRAFRAME or GUIDE LIGHT™ MT frames, it can also stand alone for travel on land or water.



KEY FEATURES:

- 1 Shoulder straps that can be swapped from duffel to backpack configuration
- 2 Large 3D zippered mesh side pockets
- 3 Large end handles
- 4 Heavy-duty reinforced daisy chains
- 5 Waterproof RF welded construction creates high-strength, leak-proof fused seams for durable, long-lasting total waterproofness



Foliage

Forest

SPECS:

Weight: 1.2 kg (2.5 lbs)
Vol: 52.7 L (3215 cu-in)
Size: One Size

HIGH WATER FLIP

Designed to keep your gear dry and ready for whatever your mission may be. The HIGH WATER FLIP pack is made for being in the office, on the trailhead, or on the water.



KEY FEATURES:

- 1 Classic flip-top lid opening
 - 2 Side-to-back compression straps
 - 3 Fixed harnessing with padded shoulders and body panel
 - 4 Waterproof RF welded construction creates high-strength, leak-proof fused seams for durable, long-lasting total waterproofness
- Vented lid pocket
 - Floating, padded sleeve fits laptops up to 15"



Foliage

Forest

SPECS:

Weight: 0.9 kg (2 lbs)
Vol: 22.9 L (1395 cu-in)
Size: One Size

HIGH WATER FORAGER

A watertight accessory pocket to keep your small stuff dry and organized. On the river or caught in a storm, your small accessories will stay protected from the elements.



KEY FEATURES:

- 1 RF Welded construction creates high-strength fused, leak-proof seams for total waterproofness
- 2 MOLLE attach for secure, easy access



Foliage

Forest

SPECS:

Weight: 0.05 kg (0.12 lb)
Vol: 1.5 L (90 cu-in)
Dims: 4.7" x 8" x 1.5"

HIGH WATER HIP PACK

This cross-over body/hip pack is perfect for any adventure that gets you out of the house. Throwing flies, floating the river, or keeping your stuff safe from spills at a concert, the HIGH WATER HIP PACK is your simple solution for ultimate protection.

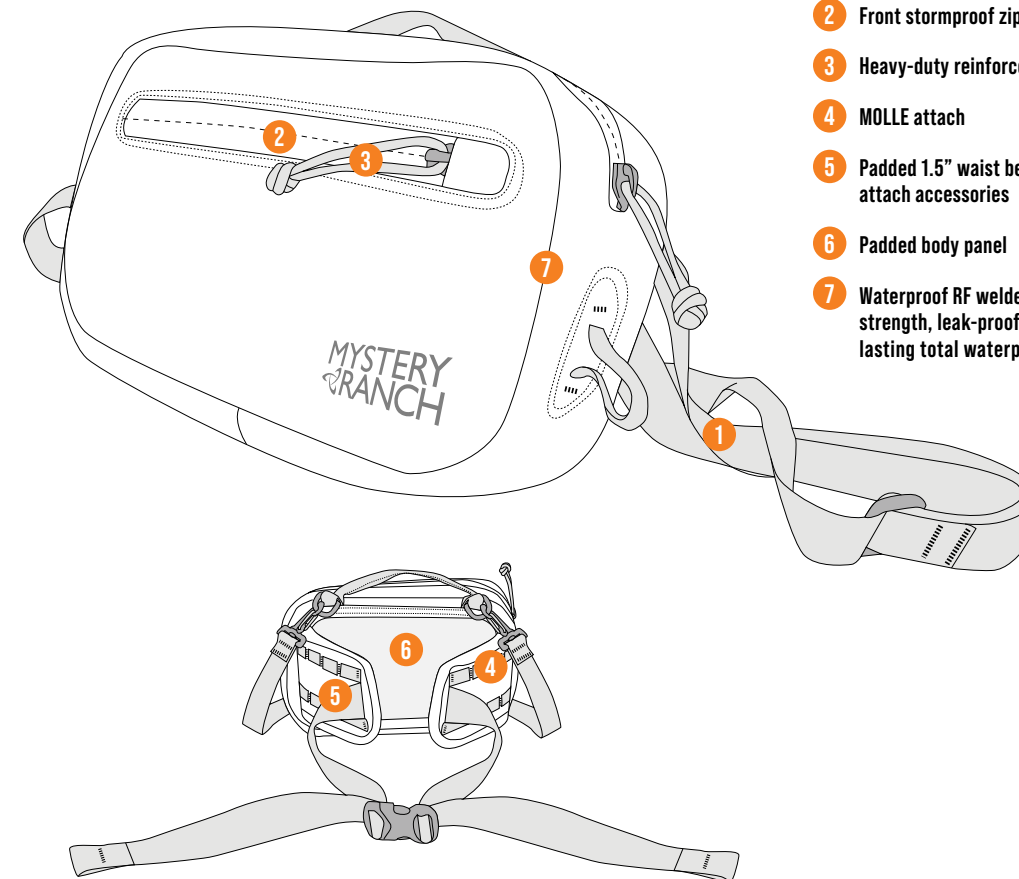

KEY FEATURES:

- 1 1"-wide removable, adjustable shoulder strap
- 2 Front stormproof zippered pocket
- 3 Heavy-duty reinforced zip pull tabs
- 4 MOLLE attach
- 5 Padded 1.5" waist belt with PALS webbing for MOLLE attach accessories
- 6 Padded body panel
- 7 Waterproof RF welded construction creates high-strength, leak-proof fused seams for durable, long-lasting total waterproofness

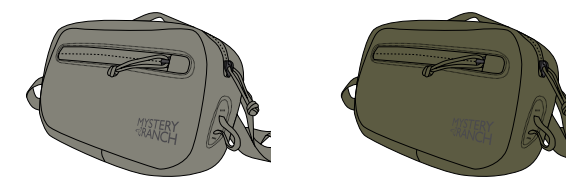

Foliage

Forest

SPECS:

Weight: 0.4 kg (0.93 lb)
Vol: 5 L (305 cu-in)
Size: One Size

HIGH WATER LID

Whether stalking or just summiting, the fully waterproof HIGH WATER LID adds an extra layer of protection to the gear you need the most. This lid ensures that the gear you need stays dry—regardless of what brings you to the backcountry.

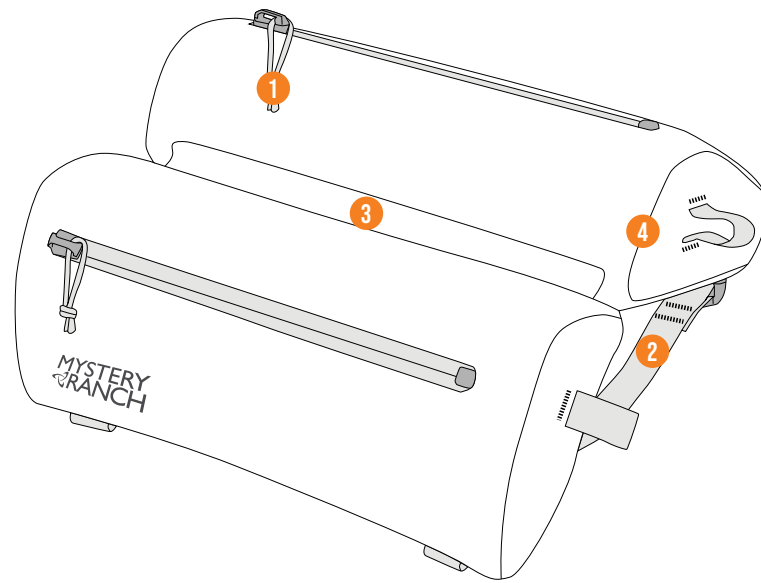

KEY FEATURES:

- 1 Heavy-duty reinforced zip pull tabs
 - 2 Removable adjustable accessory strap included
 - 3 Butterfly hinge between pockets
 - 4 Waterproof RF welded construction creates high-strength, leak-proof fused seams for durable, long-lasting total waterproofness
- Attaches to any MR Guide Light MT™ or Terraframe pack

HIGH WATER SHOULDER BAG

A shoulder bag that allows you to go straight from the paddle board to the patio. It is totally waterproof, easily accessible, and offers reliable protection making this a multi-use, user-friendly, street-worthy bag.

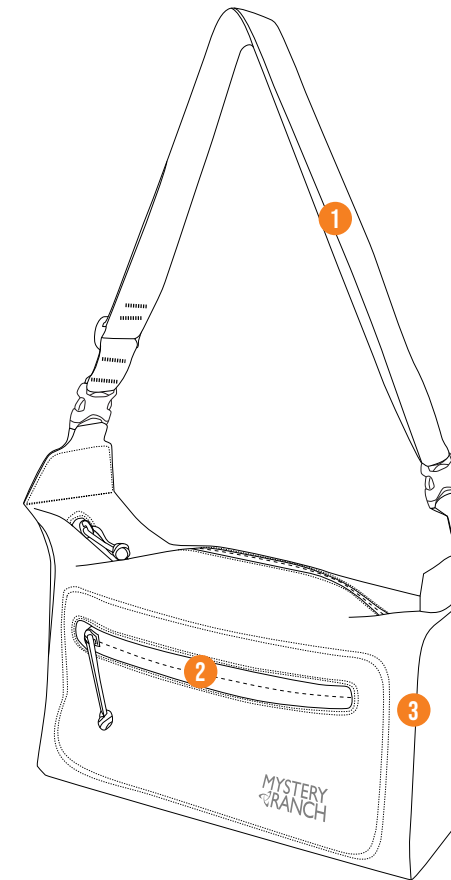

KEY FEATURES:

- 1 1.5"-wide removable, adjustable shoulder strap
 - 2 Front stormproof zippered pocket
 - 3 Waterproof RF welded construction creates high-strength fused, leak-proof seams for durable, long-lasting total waterproofness
- Heavy-duty reinforced daisy chains
 - Internal zippered pocket

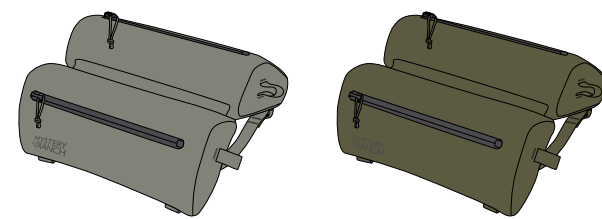

Foliage

Forest

SPECS:

Weight: 0.3 kg (1.7 lb)
Vol: 8 L (488.2 cu-in)
Size: One Size



Foliage

Forest

SPECS:

Weight: 0.4 kg (1 lb)
Vol: 9.9 L (604 cu-in)
Size: One Size



DAYPACKS

Our daypacks are workhorses for quick outings, scouting trips, or short adventures.

A versatile assortment that offers flexibility where you need it — on the trail, shed hunting, or preparing for your next hunt.

GALLAGATOR

This 3-Zip, durably built lightweight pack is ideal for navigating urban trails, scrambling on dirt, or going for a quick scout. No matter the outing, this pack prefers the scenic route.



KEY FEATURES:

- 1 Classic 3-Zip design for easy, rapid access to the interior
- 2 Zippered lid pocket
- 3 Stretch-woven water bottle pockets
 - Light, flexible, padded frame
 - Breathable air mesh back panel
 - Removable web waist belt



Black



Foliage

SPECS:

- Weight:** 0.6 kg (1.3 lb)
Vol: 19 L (1160 cu-in)
Size: One Size



IN & OUT 22

This small and mighty pack boasts many of the features of a day pack, and can be stuffed into its own front mesh pocket down to the size of a small water bottle. With easy top-loading access, contoured shoulder straps, and a sternum strap, this durable pack will get you IN & OUT.

KEY FEATURES:

- 1 Top-loading shroud with drawstring access and lid flap for extra weather protection
- 2 Two external zippered access pockets
- 3 Stretchy side pocket for water bottle or other small essentials
 - Thin breathable shoulder pads with adjustable sternum strap
 - Hydration reservoir-compatible
 - Stuffs into its own front pocket

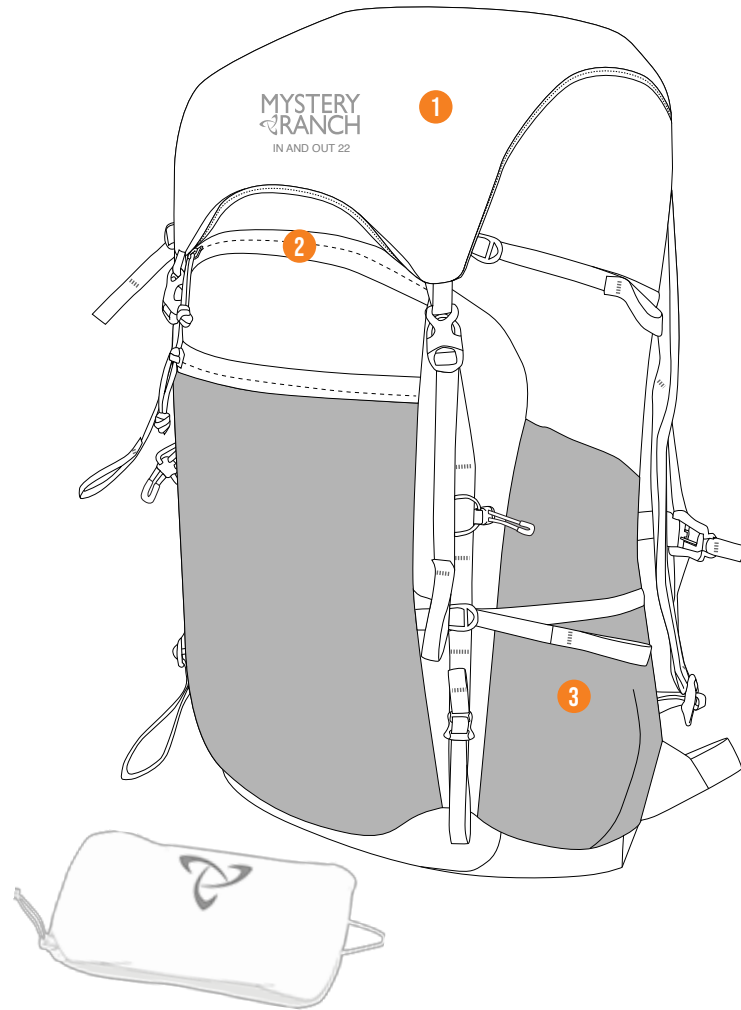

Hummus



Mineral Gray

SPECS:

Weight: 0.4 kg (0.9 lb)
Vol: 21.9 L (1335 cu-in)
Size: One Size

IN & OUT 19

This featherweight daypack is your perfect packable option. Designed to stuff into its own front mesh pocket this small daypack features contoured shoulder straps and a sternum strap for a comfortable, fast, and lightweight packable option.

KEY FEATURES:

- 1 Large, zippered access to main bag
- 2 Two external zippered access pockets
- 3 Stretchy side pocket for water bottle or other small essentials
 - Thin breathable shoulder pads with adjustable sternum strap
 - Hydration reservoir-compatible
 - Stuffs into its own front pocket

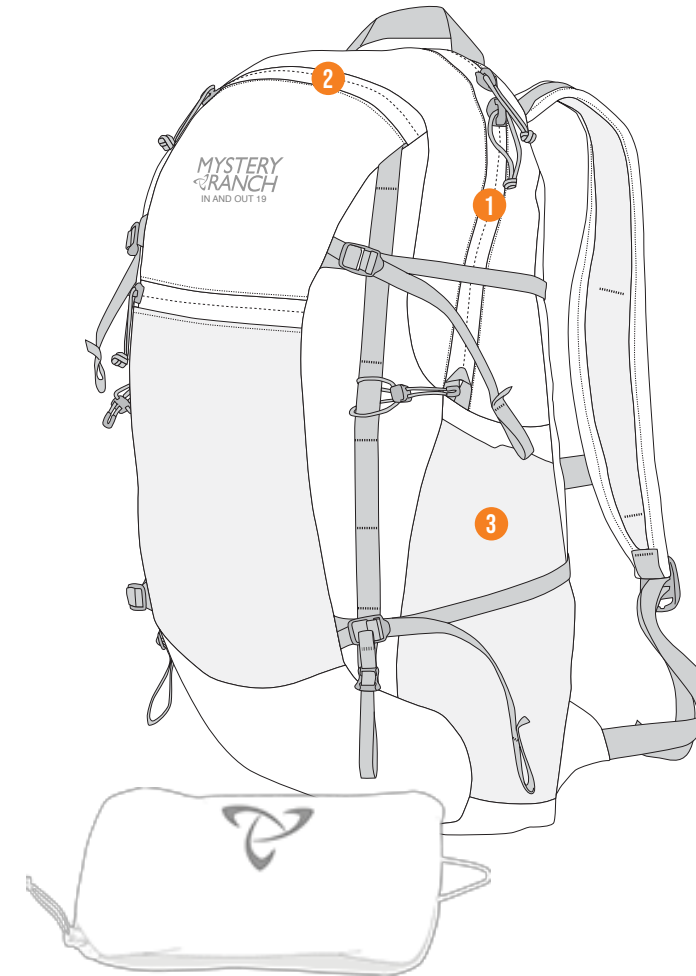

Black



Mineral Gray



Hummus



Hunter

SPECS:

Weight: 0.4 kg (0.9 lb)
Vol: 18.8 L (1145 cu-in)
Size: One Size

EVERYDAY CARRY

Like our burliest big rigs, these everyday carry packs are built to survive the long haul.

Whether the mission is work, travel, school, or all of the above, these feature-rich packs come in multiple styles to suit your needs.

2-DAY ASSAULT

From the aspiring to retired gunfighters, the 2-DAY is MYSTERY RANCH's nod to the ultra-success of the 3-Day Assault Pack. It's a scaled-down option for non-military enthusiasts built into a smaller, everyday urban size and functionality.

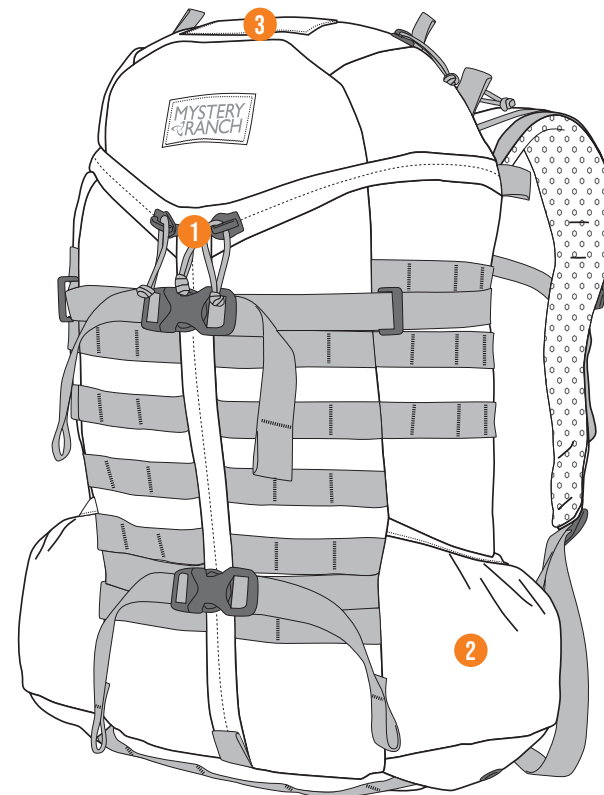

KEY FEATURES:

- 1 Classic 3-ZIP design for easy, rapid access to the interior
- 2 External bottle pockets
- 3 Two zippered lid pockets with VELCRO® on top of lid for moral patches
- Main compartment and side zip access to floating, padded sleeve that fits laptops up to 15" and document/table sleeve pocket
- Interior dump pockets
- Removable web waist belt



Black



DPM Camo



Forest



Coyote



Foliage



Wildfire Black

SPECS:

Weight: 1.4 kg (3 lbs)

Vol: 27 L (1650 cu-in)

Sizes: S/M L/XL

NEW

3 WAY 18

This briefcase lives at the intersection of your commuting needs, doubling as a shoulder bag, transforming into a backpack, and doing it all with environmentally conscious organizational wizardry.



KEY FEATURES:

- 1 Front Rip-Zip pocket with magnet buckle, mesh zippered pocket, and stretch fabric detail pockets
- 2 Expandable zipper design creates five more liters of space
- 3 Main compartment has stretch woven detail pockets backed with soft material for headphones
 - Additional divider in the main compartment with a zippered pocket and stretch detail pockets
 - Body panel pocket has padded laptop sleeve (fits laptops up to a 15"), and a dump pouch with detail pockets
 - Sustainably made with recycled materials



Black Sagebrush Shadow



Tiger's Eye Wildfire Black

SPECS:

Weight: 1.27 kg (2.74 lbs)
 Vol: 2.7 L (1100 cu-in)
 Size: One Size

NEW

3 WAY 27

It's a briefcase! It's a shoulder bag! It's a backpack! It's...all three? Yep, the 3 WAY 27 is bigger, roomier, and more environmentally friendly than ever.



KEY FEATURES:

- 1 Front Rip-Zip pocket with magnet buckle, mesh zippered pocket, and stretch fabric detail pockets
- 2 Clam shell opening to the main compartment for easy access and an elastic retention band
- 3 Main compartment has stretch woven detail pockets backed with soft material for headphones
 - Body panel pocket has padded laptop sleeve (fits laptops up to a 17"), and a dump pouch with detail pockets
 - Sustainably made with recycled materials



Black Sagebrush



Shadow Tiger's Eye

SPECS:

Weight: 1.41 kg (3.1 lbs)
 Vol: 27 L (1650 cu-in)
 Size: One Size

NEW

CATALYST 18

This super functional pack was made to handle whatever your everyday mission throws at you. With its tough yet environmentally friendly CORDURA® body, it's up for outdoor adventures too.

KEY FEATURES:

- 1 3-ZIP design for rapid access to interior
 - Padded laptop pocket with elastic holds laptops up to a 15" in size
 - Additional sleeve on the front of the laptop pocket holds a tablet, notebooks, maps, etc.
 - Two internal zippered pockets to hold those small-but-important items
 - Sustainably made with recycled materials

CORDURA
re/cor™

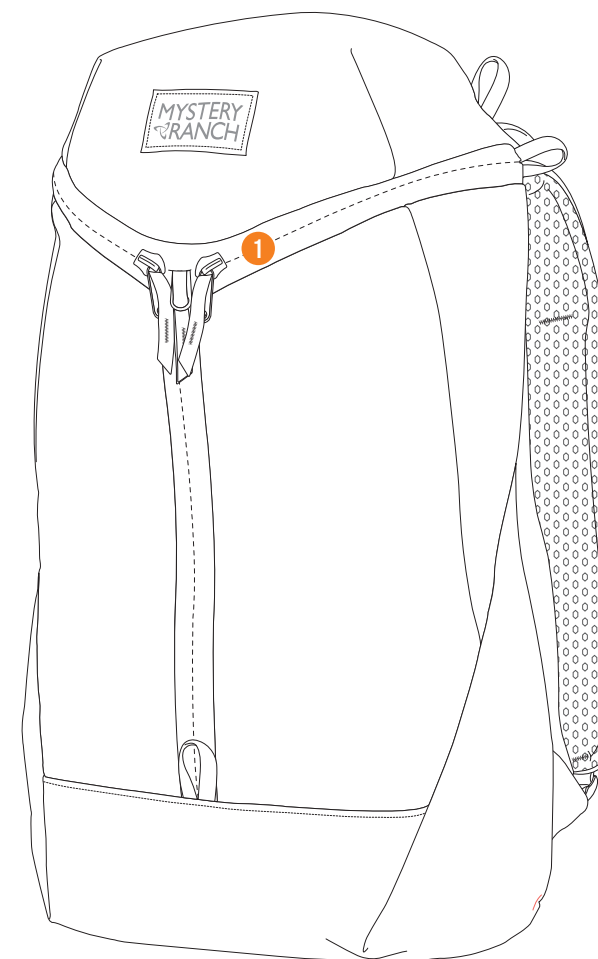

Stone

Paprika

Black

Noble Fir

SPECS:

Weight: .8 kg (1.8 lbs)

Vol: 21 L (1100 cu-in)

Size: One Size



NEW

CATALYST 22

You don't have to compromise with this tough yet eco-friendly backpack. The CATALYST 22 can be used both in the office and on the trail.



KEY FEATURES:

- 1 3-ZIP design for rapid access to interior
- 2 Two external water bottle pockets, one on each side, fit most bottles
 - Additional sleeve on the front of the laptop pocket holds a tablet, notebooks, maps, etc.
 - Two internal zippered pockets to hold those small-but-important items
 - Padded laptop pocket with elastic holds laptops up to a 16" in size
 - Sustainably made with recycled materials



SPECS:

Weight: 1 kg (2.16 lbs)
 Vol: 21 L (1280 cu-in)
 Size: One Size

NEW

CATALYST 26

A versatile pack built to withstand any urban adventure. With its tough yet environmentally friendly CORDURA® body, it's ready for the outdoors too.

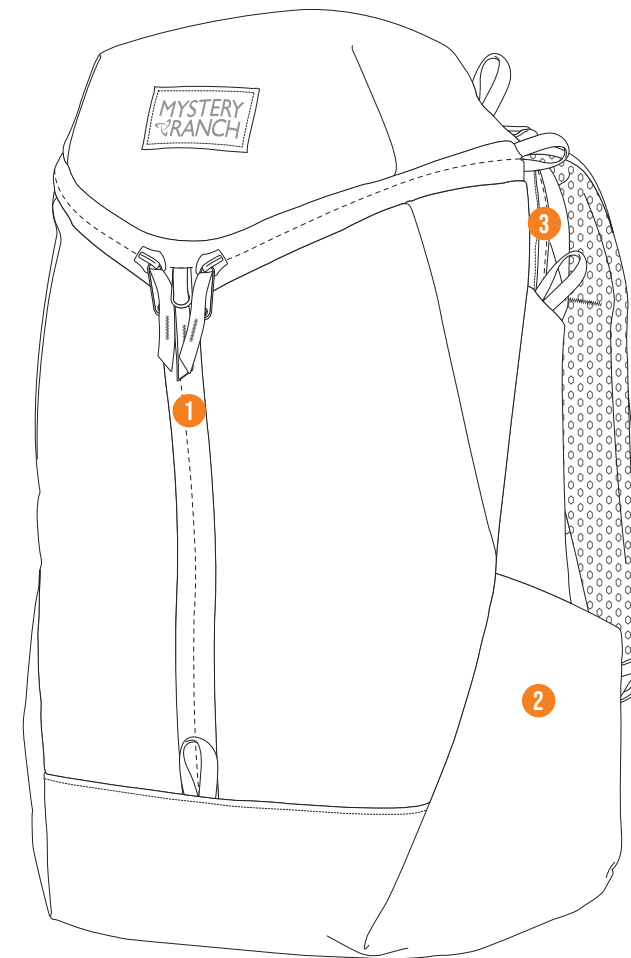

KEY FEATURES:

- 1 3-ZIP design for rapid access to interior
- 2 Two external water bottle pockets, one on each side, fit most bottles
- 3 Dedicated zippered padded laptop pocket with a divider to hold both a laptop (up to 17") and tablet
 - Organizational sleeve on the inside of the bag includes a small, zippered mesh pocket, a dump pocket for a charging cord or water bottle, and two rows of elastic to hold pens, wires, or pocket knives
 - Two internal zippered pockets to hold those small-but-important items
 - Sustainably made with recycled materials



SPECS:

Weight: 1.16 kg (2.56 lbs)
 Vol: 25.8 L (1575 cu-in)
 Size: One Size

BLITZ 30

The BLITZ 30 is your go-to bag that offers a tactical solution to your everyday needs. With full horseshoe-style zip access, work-rich features, and a hydro-ported body panel, the pack can go from the office to off-road in a hurry.



KEY FEATURES:

- 1 Full zipper access with wrap-around zipper panel
- 2 Three front pockets and ample PALS webbing
- 3 Zippered access to laptop sleeve from body panel
- 4 Side pocket
 - Removable webbing waist belt
 - Padded floating laptop sleeve

BLITZ 35

Whether work, school or in the middle of nowhere, this top-loading tank of a pack is perfect for your everyday missions. Side zip access and plenty of pockets allow you to be organized for your commute to the office or overlanding.

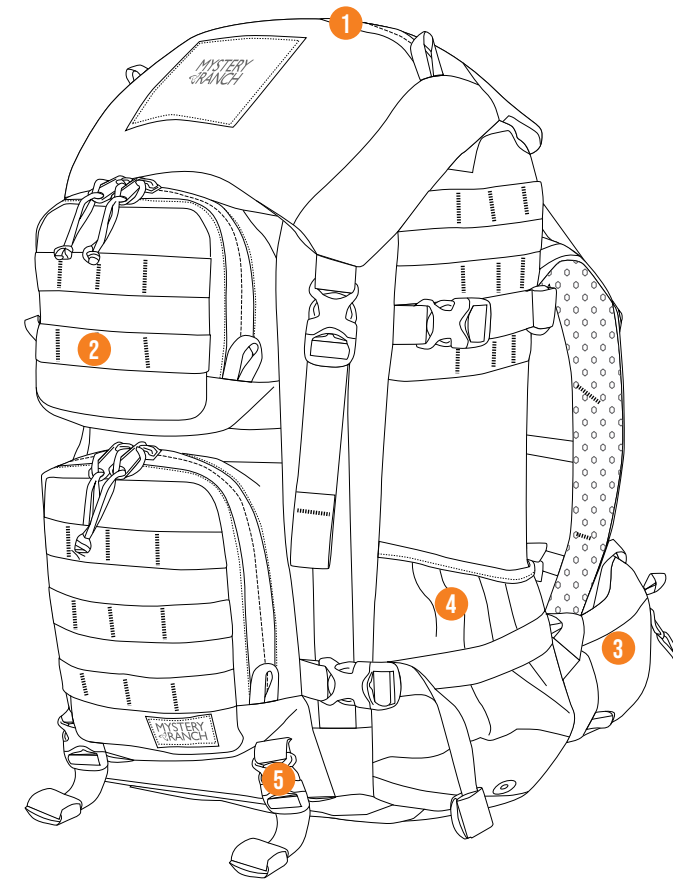

KEY FEATURES:

- 1 Lid with zippered pocket
- 2 Three front pockets and ample PALS webbing
- 3 Removable pocketed waist belt
- 4 Side pocket
- 5 Side and lower compression straps
 - Padded, floating laptop sleeve
 - Top loader with side zip access



Coyote

Forest

Black

SPECS:

Weight: 1.2 kg (2.7 lbs)
 Vol: 29 L (1770 cu-in)
 Sizes: S/M L/XL



Coyote

Forest

Black

SPECS:

Weight: 2 kg (4.4 lbs)
 Vol: 35.8 L (2185 cu-in)
 Sizes: S/M L/XL



DISTRICT 18

This recycled, fixed-harness pack blends style, function, and durability. A top admin pocket, dual-side water bottle pockets, and a padded tablet or laptop sleeve all make for a perfect companion for any kind of commute.

KEY FEATURES:

- 1 Two stretch-woven side bottle pockets
- 2 Front pocket with hook and loop access and side zip for full access
- 3 Open cell foam padded shoulder pads and body panel
 - Internal divider with two detail pockets
 - Sustainably made from recycled materials
 - Protective padded, floating sleeve that fits a 15" laptop

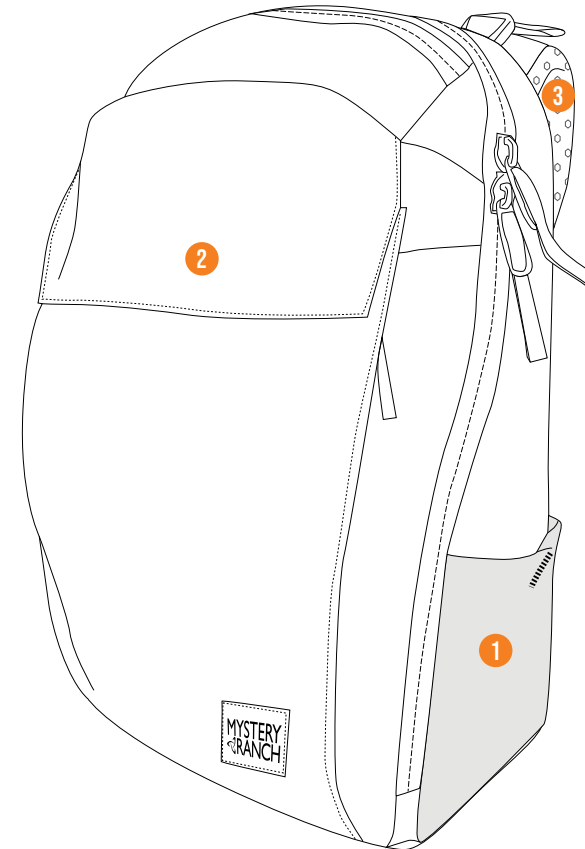

Shadow



Black

SPECS:

- Weight:** 1.2 kg (2.6 lbs)
Vol: 18.9 L (1155 cu-in)
Size: One Size

DISTRICT 24

This recycled 24-liter pack offers the same notable features as the 18 but fits a 17" laptop and has a little extra room for whatever is essential for the day. Go ahead, take more.

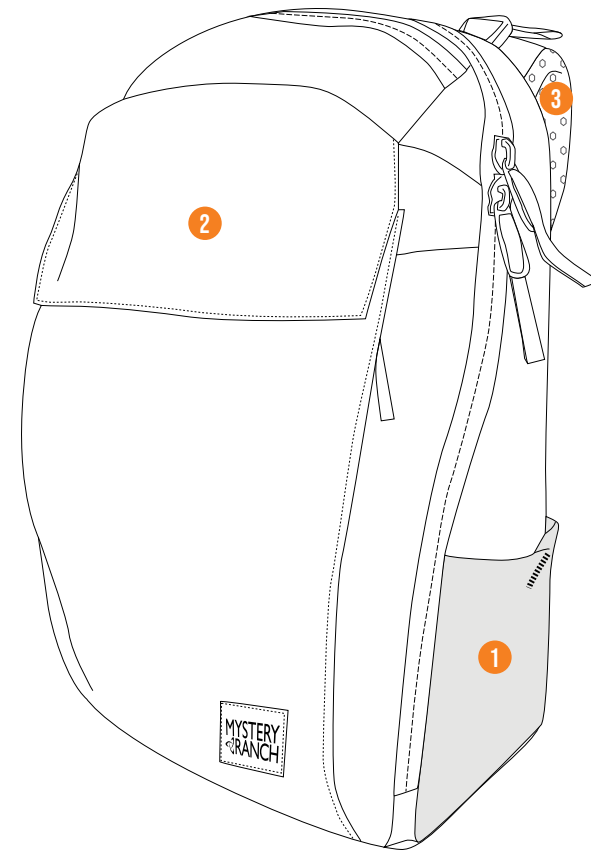

KEY FEATURES:

- 1 Dual stretch-woven side bottle pockets
- 2 Front pocket with hook and loop access and side zip for full access
- 3 Open cell foam padded shoulder pads and body panel
 - Internal divider with two detail pockets
 - Sustainably made from recycled materials
 - Protective padded, floating sleeve that fits a 17" laptop



Shadow

Black

SPECS:

Weight: 1.24 kg (2.74 lbs)
Vol: 23 L (1405 cu-in)
Size: One Size

RIP RUCK 15

The smallest in the RIP RUCK series, this pack has a main Rip-Zip compartment that has a laptop and document sleeve, a zippered mesh pocket, and two internal side pockets. Its low-profile, minimalist design will make any commute less of a hassle.

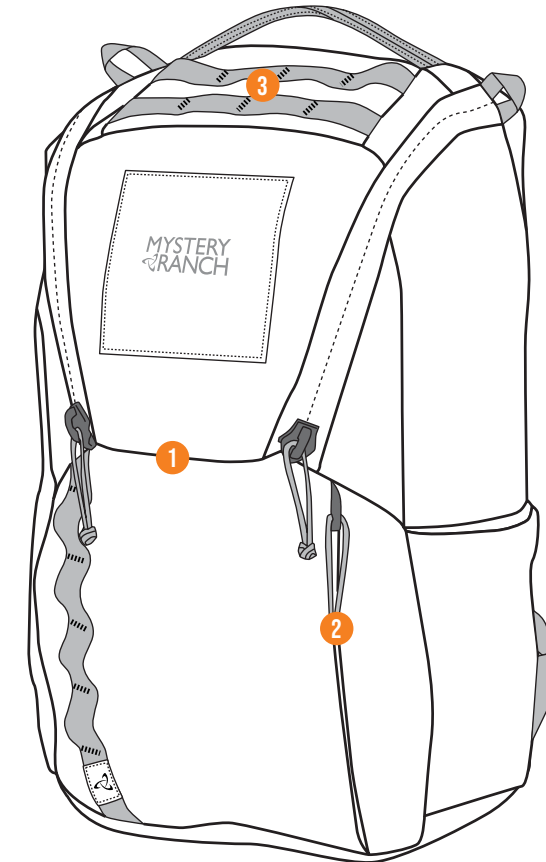

KEY FEATURES:

- 1 Quick Rip-Zip panel access to drop-in compartment for easy one-handed open and close that is secured with magnets
- 2 Vertical entry zippered face pocket with interior dividers
- 3 PALS Webbing on top of lid for MOLLE accessories
 - Floating padded sleeve with Velcro closure fits laptops up to 15"
 - Additional document sleeve is lined with Velcro for attaching accessories



Black

Foliage

Forest

Wood

SPECS:

Weight: 0.7 kg (1.6 lb)
Vol: 15 L (915 cu-in)
Size: One Size

RIP RUCK 24

This mid-size pack in the RIP RUCK series will be your best travel companion because of its organization. It has two main compartments: a zip access to a separate laptop and document sleeve and a Rip-Zip compartment that has a sleeve, zippered mesh pocket, and plenty of space for all of your other must-haves.

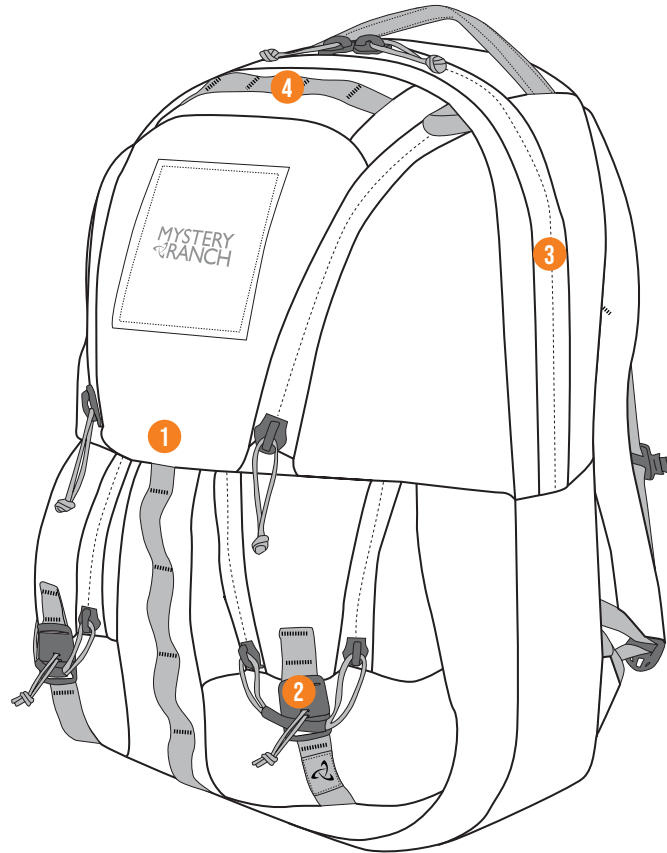

KEY FEATURES:

- 1 Quick Rip-Zip panel access to drop-in compartment for easy one-handed open and close that is secured with magnets
- 2 Two lower Rip-Zip pockets with quick-pull magnetic open and close
- 3 Laptop pocket with sleeves for papers and notebooks, holds up to a 15" laptop
- 4 PALS Webbing on top of lid for MOLLE accessories
 - Floating padded sleeve lined with buffalo fuzz fits laptops up to 15"
 - Additional document sleeve



SPECS:

Weight: 1.0 kg (2.3 lbs)
Vol: 24 L (1465 cu-in)
Size: One Size

RIP RUCK 32

Inspired by the military ALICE RUCK, the RIP RUCK 32 is the largest of the series. This Swiss Army Knife of a pack is full of pockets and organizational features that work well for travel, the office, and everywhere in between.

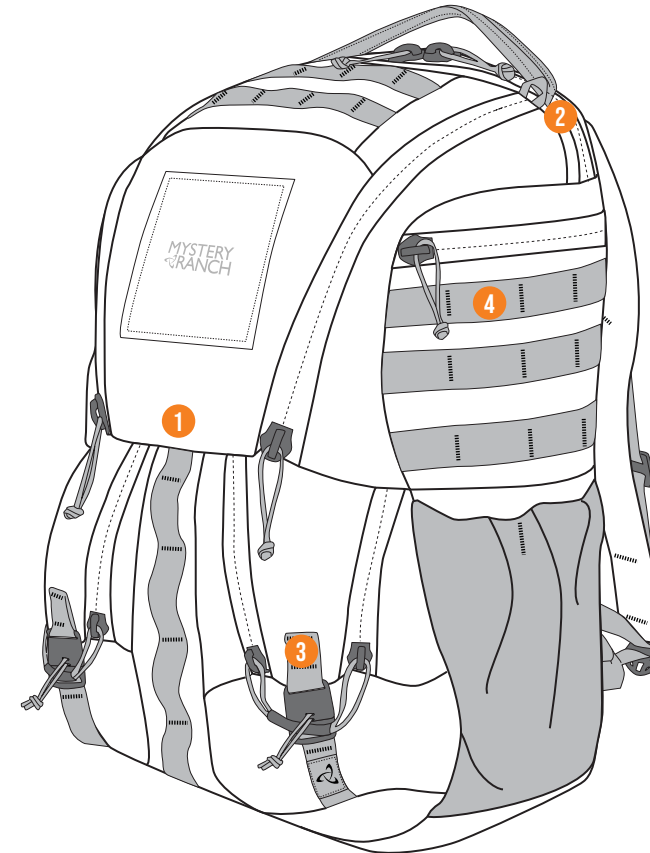

KEY FEATURES:

- 1 Quick Rip-Zip panel access to drop-in compartment for easy one-handed open and close that is secured with magnets
- 2 Top zip access to separate laptop and document compartment (fits laptop up to 15")
- 3 Two lower Rip-Zip pockets with quick-pull magnetic open and close
- 4 Two upper exterior zipper pockets
 - Rip-Zip compartment has divided, zippered mesh pocket and document sleeve
 - Stowable waist belt tucks into compartments beneath the water bottle pockets when not in use



SPECS:

Weight: 1.7 kg (3.8 lbs)
Vol: 32 L (1955 cu-in)
Sizes: S/M L/XL

HIP MONKEY

The HIP MONKEY's exterior is deceptively trim, but it can easily swallow an extra layer, gloves, water bottle, headlamp or kill kit etc. Accommodate your favorite six pack or a few fly boxes for an afternoon on the river.

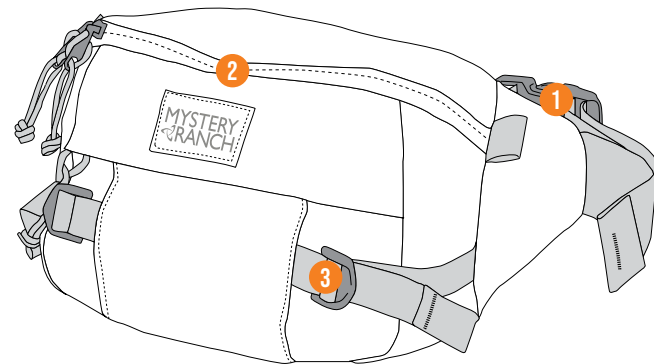

KEY FEATURES:

- 1 Waist belt is designed for carrying around the hips or over the shoulder
- 2 Zippered access to main bag
- 3 Dual-compression straps
 - Front pocket with key clip

SPECS:

Weight: 0.4 kg (0.9 lb)
Vol: 8 L (490 cu-in)
Size: One Size



Black



DPM Camo



Mineral Gray

SUPERSET 30

A gym bag that you can choose how to use. This highly versatile bag meets your ever-changing needs with deployable shoulder pads, side grab handles, and body panel zip access.

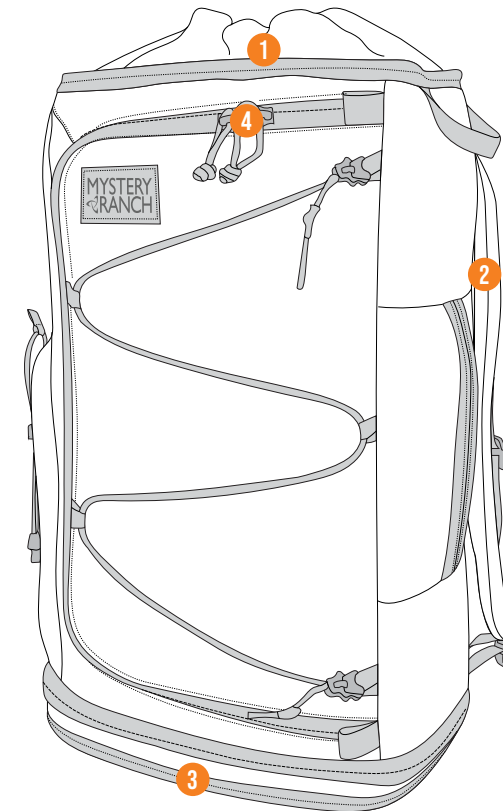

KEY FEATURES:

- 1 Multiple access points to the main bag via duffel style opening or top-loading shroud
- 2 Stowable, padded shoulder pads
- 3 Zippered boot compartment for shoes or dirty gym clothes
- 4 Large, zippered back pocket
 - Internal computer sleeve and a separate compartment on the bottom of the bag

SPECS:

Weight: 1 kg (2.3 lbs)
Vol: 27.8 L (1695 cu-in)
Size: One Size



Black

TRAVEL

Haul cargo for any mission—the rugged material of these packs will stand up to constant abuse.

Be it the back of the truck, a horse pack, or the overhead compartment — these packs are BUILT FOR THE MISSION.

MISSION DUFFELS

These top-of-the-line travel duffels are water-resistant, loaded with pockets and organizational options, and offer multiple ways to carry. It will be your number one travel companion.

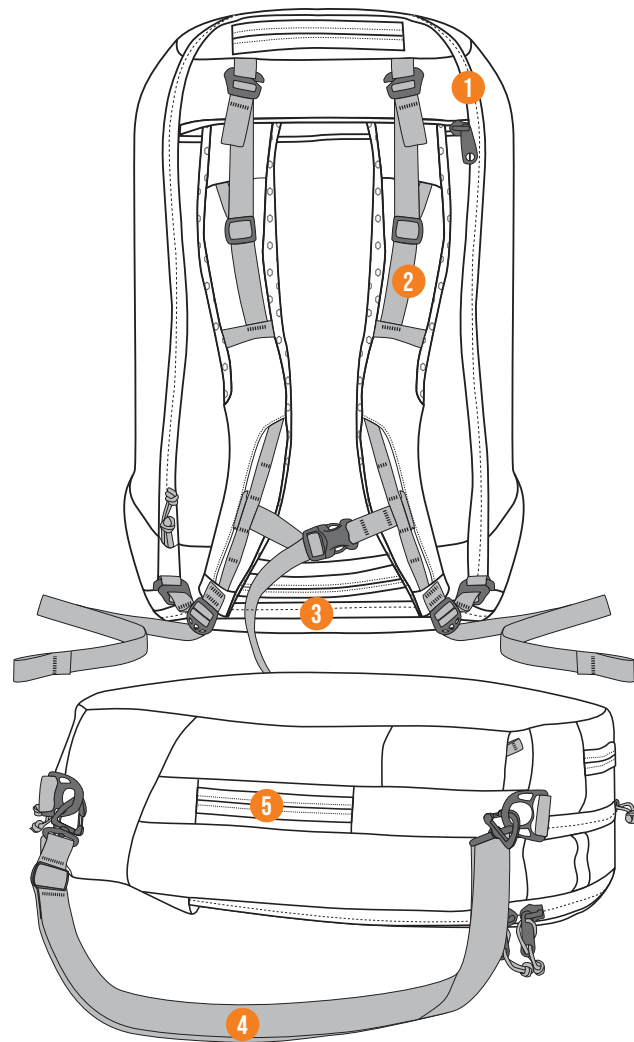

KEY FEATURES:

- 1 Horseshoe-shaped zipper provides easy access to entire bag
- 2 Stowable shoulder pads convert this duffel into a backpack
- 3 Exterior access laundry and boot compartments
- 4 Removable, adjustable shoulder strap
- 5 Four exterior handles (one on each side) and four interior zipper pockets

SPECS:

40
Weight: 1.4 kg (3.1 lbs)
Vol: 41.7 L (2545 cu-in)
Size: One Size
Colors: Shadow, Waxed Wood

55
Weight: 1.6 kg (3.4 lbs)
Vol: 55 L (3355 cu-in)
Size: One Size
Colors: Shadow, Waxed Wood

90
Weight: 1.9 kg (4.2 lbs)
Vol: 93.8 L (5725 cu-in)
Size: One Size
Colors: Shadow

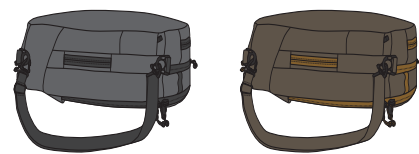

Shadow 10000

Wood Waxed

MISSION ROVERS

These sleek yet ample backpack suitcases can fit all of your crucial travel necessities. Available in three sizes, the MISSION ROVERS are workhorse gear haulers, designed to accommodate varying loads and strategically separate your stuff.



KEY FEATURES:

- 1 Clam-shell zippered access to easily pack and organize
- 2 3-way carry: suitcase, shoulder, or backpack-style (stowable)
- 3 Dirty laundry/shoe compartment
 - Padded sleeve fits laptops up to 15"
 - Rolling luggage handle pass-through

SPECS:

60 PLUS
Weight: 2.2 kg (4.9 lbs)
Vol: 59.6 L (3637 cu-in),
 Expandable to 75 L (4577 cu-in)
Size: One Size

45
Weight: 1.9 kg (4.3 lbs)
Vol: 42 L (2563 cu-in)
Size: One Size

30
Weight: 1.6 kg (3.5 lbs)
Vol: 29.2 L (1781.9 cu-in)
Size: One Size

*all sizes available in all colors



Black

Shadow

Wood Waxed

MISSION STUFFELS

Born in the same style as our MISSION DUFFEL and nesting into its own boot compartment, this convertible duffel takes up less space than a sweater when packed, making it a no-brainer to toss into your bag to accommodate the extra goodies you picked up on your trip – and freeing up floor space that traditional luggage has a hold on.

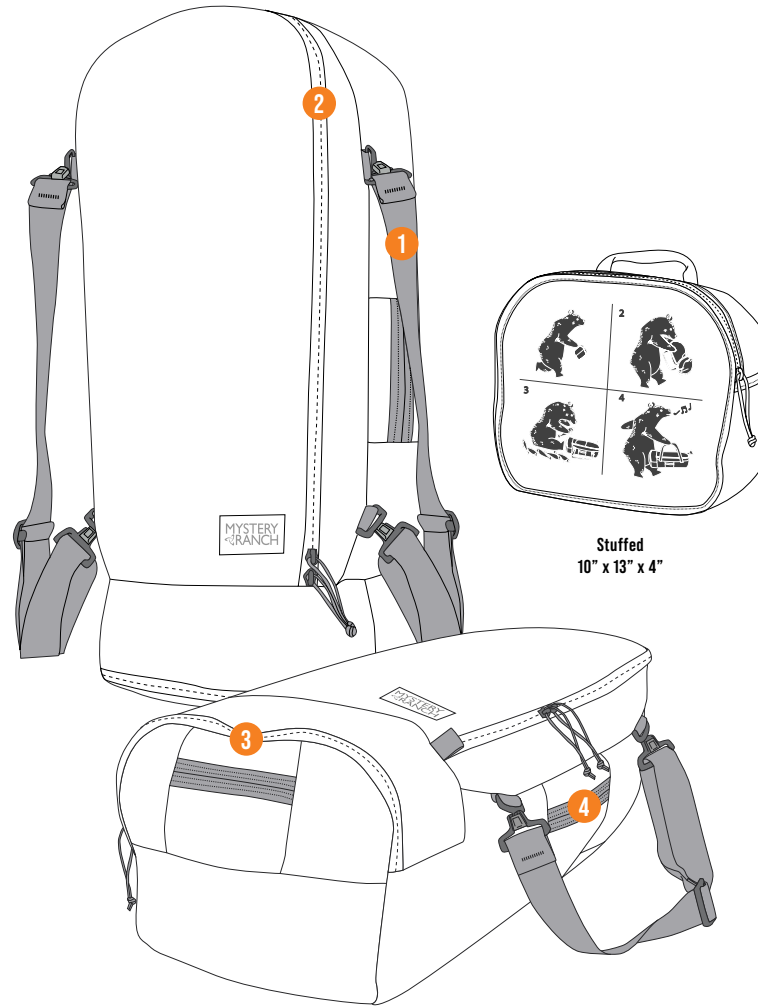

KEY FEATURES:

- 1 Shoulder straps can be worn as a backpack or easily removed for quick storage
- 2 Huge main compartment access through a long horseshow opening
- 3 Zippered boot compartment where pack also stuffs into
- 4 A handle on all four sides

SPECS:

60
Weight: 0.7 kg (1.5 lb)
Vol: 58.4 L (3565 cu-in)
Size: One Size

45
Weight: 0.6 kg (1.4 lb)
Vol: 44 L (2685 cu-in)
Size: One Size

30
Weight: 0.6 kg (1.2 lb)
Vol: 30.2 L (1845 cu-in)
Size: One Size



Black

Sunset

Twig

MISSION WHEELIES

Built to survive savage baggage handlers, our MISSION WHEELIES luggage collection protects your stuff on the most far-flung travels. Ample room, clever compartments, and large-diameter, off-road wheels will get you to your final destination.



KEY FEATURES:

- 1 Exterior laundry and boot compartments
- 2 Horseshoe-shaped zipper provides easy access to entire bag
- 3 Rugged, off-road wheels
- 4 Hard-sided shell and reinforced plastic sides
 - Telescoping handle
 - Four interior zipper pockets

SPECS:

130
Weight: 5 kg (11 lbs)
Vol: 130 L (7935 cu-in)

80
Weight: 4.3 kg (9.5 lbs)
Vol: 80 L (4880 cu-in)

40
Weight: 3.3 kg (7.3 lbs)
Vol: 40 L (2440 cu-in)

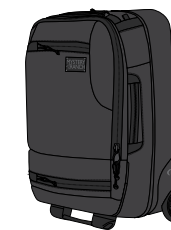

Black

A person wearing a tan, quilted jacket is shown from the side, holding a pair of black binoculars. A camouflage-patterned pouch is attached to their gear, and a white cup is visible inside it. The background is a blurred, natural outdoor setting.

ACCESSORIES

MYSTERY RANCH accessories are designed to help customize your pack and be true companions on your hunt.

Our accessories provide quick access to essentials, extra volume, additional organization, or hydration solutions for whatever outing—short or long.

NEW

CHEEKY RISER

Kill two birds with one stone with the CHEEKY RISER. This rifle stock pack offers key storage space for ammunition, Ballistic Data Cards, or tools, while providing countless riser adjustments.



KEY FEATURES:

- 1 Zippered pocket with loop patch on the front to attach ammo or data patch; interior of pocket has Buffalo Fuzz as another attach point and a vinyl detail pocket
- 2 Everything comes together at the bottom with an elastic cord lattice that is adjusted with a cord lock for optimal fit on your rifle stock
- 3 Comes with injection-molded foam shims to adjust height for perfect eye-to-scope alignment
 - Inner side is lined with Buffalo Fuzz and has a Hypalon strap with hook attach points so that it can be custom fit to the butt of the rifle

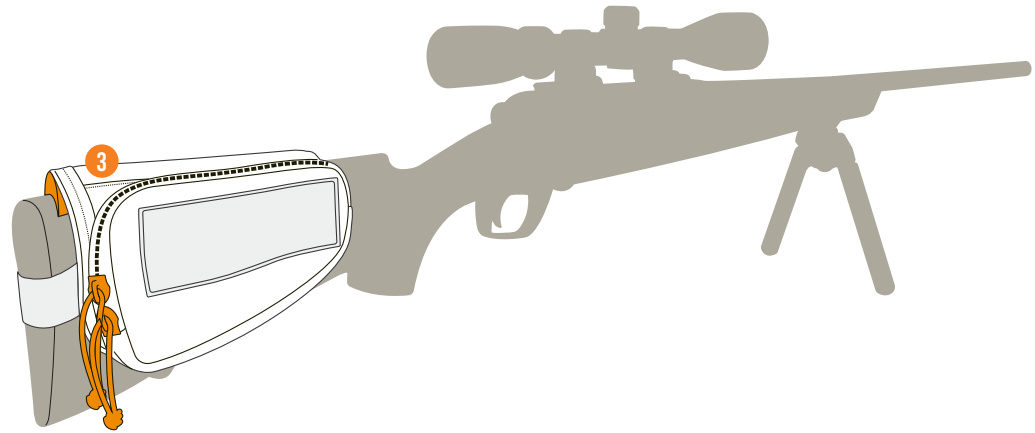

SPECS:

Weight: 0.13 kg (4.6 oz)
Size: One Size
Dims: 8.25" x 3" x 5.25"

NEW

SPOTTING SCOPE SLING

Built to fit multiple sizes of spotters, the SPOTTING SCOPE SLING protects your optics until it is time to find that buck or bull of your dreams.

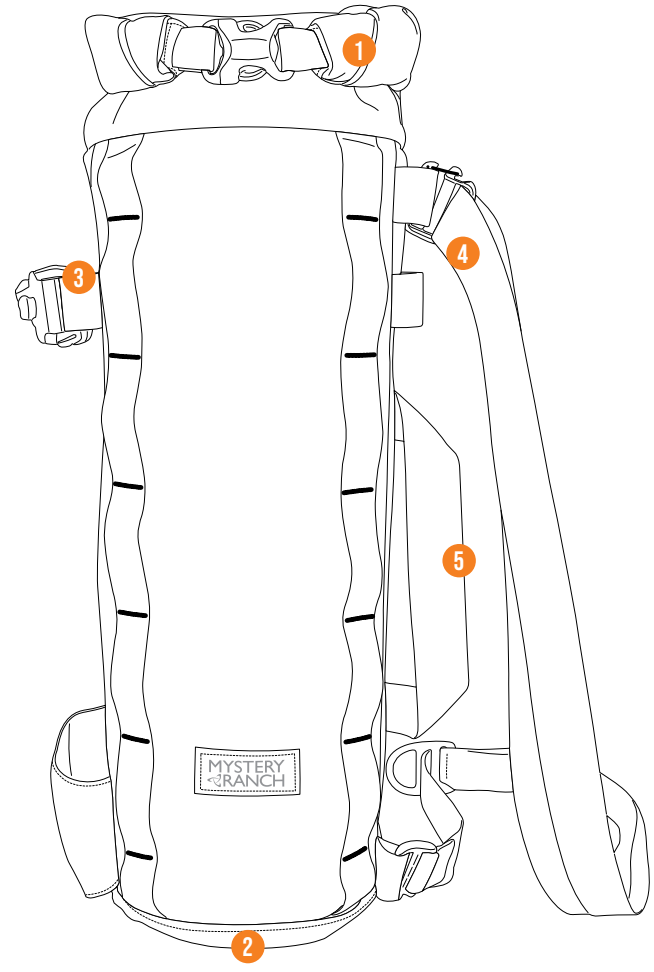

KEY FEATURES:

- 1 Roll top design to accommodate up to an 80mm straight or angled spotting scope
- 2 Flat bottom construction allows SPOTTING SCOPE SLING to stand up on its own
- 3 Side compression strap and tripod pocket for easy carry
- 4 Removable shoulder strap for alternative carrying options
- 5 Web handle for transporting by hand
 - Padded front, bottom, and sides for extra protection of eyepiece and objective lens

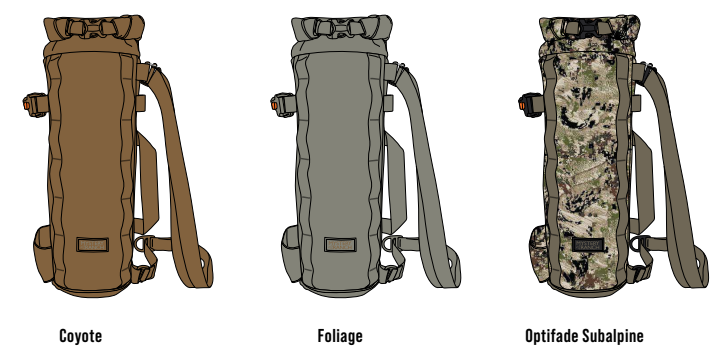

SPECS:

Weight: 0.36 kg (12.7 oz)
Size: One Size
Dims: 5.75" x 5.25" x 16.75"

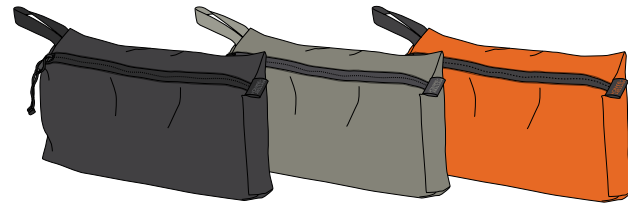

Black Foliage Hunter

ZOID BAG

Weight: 0.04 kg (1.4 oz) .07 kg (2.5 oz) .10 kg (3.5 oz)
Vol: 1.5 L (92 cu-in) 3.5 L (214 cu-in) 7 L (427 cu-in)
Dims: 6.5" x 9" x 2" 6.5" x 11.5" x 3.5" 7.5" x 15" x 5.5"
Sizes: S M L
Set: Includes one size of each



Foliage Black Hunter

QUICK ATTACH ZOID BAG

Weight: 0.06 kg (2.08 oz) 0.08 kg (2.88 oz)
Vol: 1.5L (90 cu-in) 3L (185 cu-in)
Dims: 8.5" x 5.5" x 3.5" 13.25" x 5.5" x 3.5"
Sizes: S M

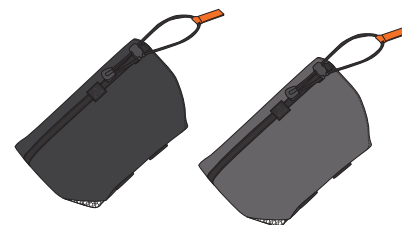

Black Shadow

REMOVABLE WATER BOTTLE POCKET

Weight: 0.1 kg (3.2 oz)
Size/Dims: One Size (7" x 4" x 4")

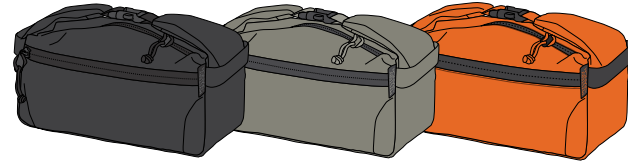

Black Foliage Hunter

ZOID CELL

Weight: 0.03 kg (10.5 oz)
Vol: 4 L (245 cu-in)
Size/Dims: One Size (6" x 12.5" x 6")



Black Foliage

DSLR CHEST RIG

Weight: 0.5 kg (17.6 oz)
Vol: 3 L (185 cu-in)
Size/Dims: One Size (9.3" x 7.3" x 6.3")



Mineral Gray

SUPER FLY PACK COVER

Weight: 0.16 kg (5.6 oz) 0.17 kg (6.08 oz) 0.21 kg (7.52 oz)
Vol: 20L-40L packs 40L-60L 60L to 105L
Sizes: S M L



Black Foliage Pebble

WINGMAN AFP

Weight: 0.07 kg (2.56 oz)
Dims: 7.25" x 5" x 0.5"
Size: One Size

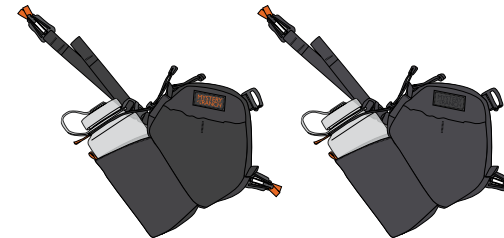

Black Shadow

WINGMAN MULTI POCKET

Weight: 0.13 kg (4.8 oz)
Vol: 1.5L (91.5 cu-in)
Dims: 7.5" x 10" x 3"
Size: One Size

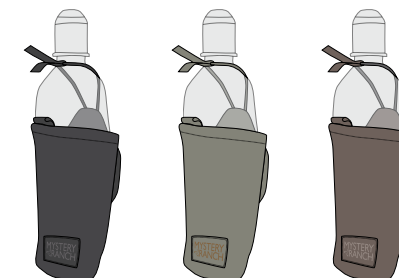

Black Foliage Pebble

WINGMAN HYDRO

Weight: 0.05 kg (1.92 oz)
Dims: 7.25" x 4" x 0.5"
Size: One Size



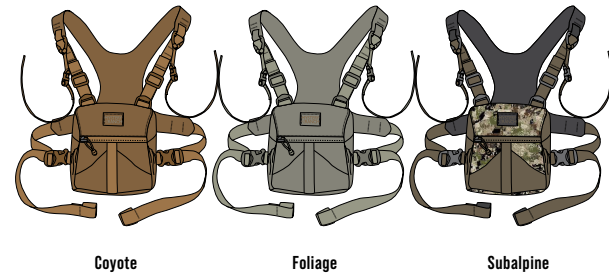
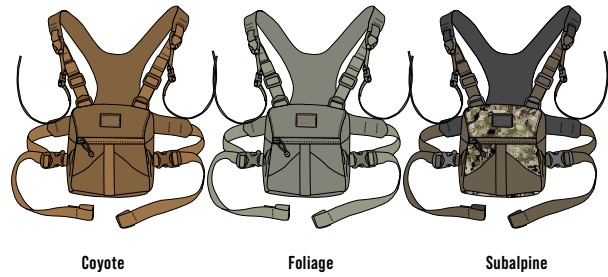

GAME BAGS

Our GAME BAGS were designed with ease-of-use in mind. This durable, lightweight, and reusable game bag can work with the MR GUIDE LIGHT MT™ framed pack in any situation where a game bag is needed.

BINO HARNESS 10X

The 10X BINO HARNESS can stand alone or attach to your pack. With quick one-handed access and room for your tools, this chest harness keeps you focused on the hunt.

- Weight:** 0.31 kg (10.88 oz)
- Vol:** Fits most 10x binoculars [height 6.75" or less]
- Dims:** 7" x 8" x 4.3"
- Size:** Regular, XL

BINO HARNESS 12X

Like its little 10X brother, the BINO HARNESS 12X can stand alone or attach to your pack. With quick one-handed magnetic closure access and pockets for your tools, this chest harness keeps you focused on the hunt.

- Weight:** 0.32 kg (11.36 oz)
- Vol:** Fits most 12x binoculars [height 6.75"-8"]
- Dims:** 9" x 8" x 3.8"
- Size:** Regular, XL

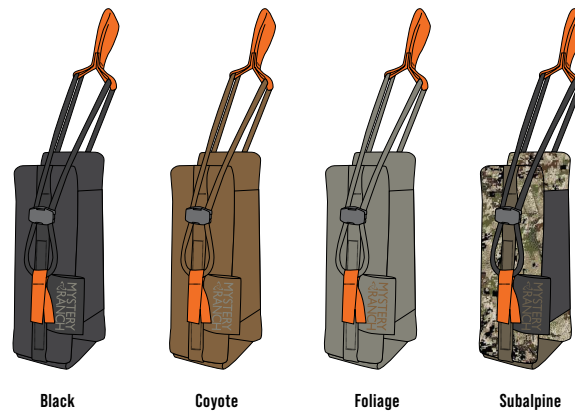

BEAR SPRAY HOLSTER

Staying safe in bear country is the priority when out in the backcountry. The BEAR SPRAY HOLSTER can be deployed while still attached to your hip, making self-protection fast and easy.

- Weight:** 0.06 kg (2 oz)
- Vol:** Canisters from 7.9 oz - 13.4 oz from all major manufacturers

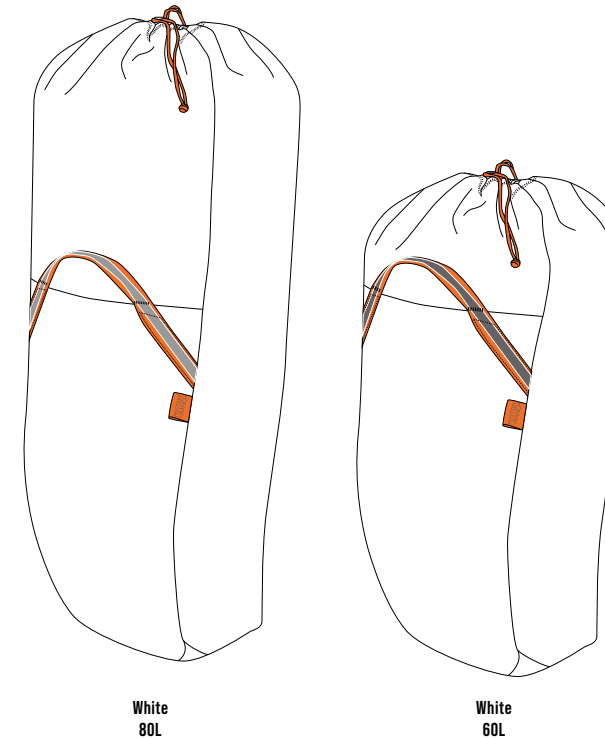

White 80L

White 60L

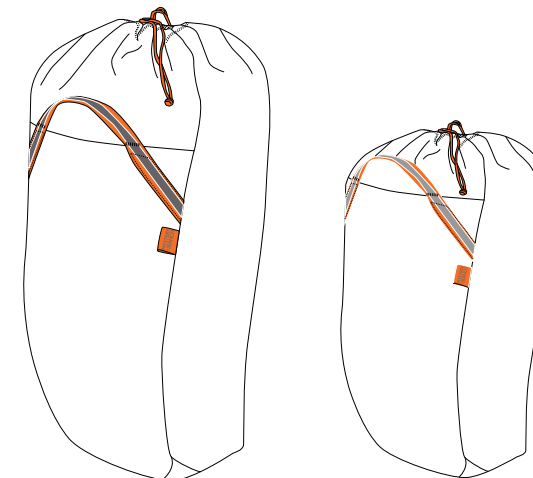

White 40L

White 20L

SPECS:

- 80**
- Weight:** 0.32 kg (11.2 oz)
- Vol:** 80 L (4881.9 cu-in)
- Dims:** 34" x 14" x 12"

- 60**
- Weight:** 0.23 kg (8 oz)
- Vol:** 60 L (3661.4 cu-in)
- Dims:** 28" x 12" x 12"

- 40**
- Weight:** 0.2 kg (6.4 oz)
- Vol:** 43 L (2625 cu-in)
- Dims:** 26" x 11" x 10"

- 20**
- Weight:** 0.1 kg (4.16 oz)
- Vol:** 23 L (1405 cu-in)
- Dims:** 19" x 9" x 9"

GAME BAG KIT

Set comes with two (2) Game Bag 60, (2) Game Bag 40, (1) Game Bag 20, and a Large Zoid Bag

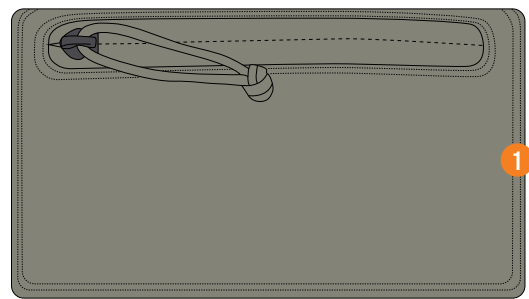

Foliage



Forest

HIGH WATER FORAGER

A water tight accessory pocket to keep your small stuff dry and organized. On the river or caught in a storm, your small accessories will stay protected from the elements.

KEY FEATURES:

- 1 RF Welded construction creates high-strength fused, leak-proof seams for total waterproofness
- MOLLE attach for secure, easy access

SPECS:

Weight: 0.05 kg (1.92 oz)
 Vol: 1.5 L (91.5 cu-in)
 Dims: 4.7" X 8" X 1.5"

HIGH WATER LID

Whether stalking or just summiting, the fully waterproof HIGH WATER LID adds an extra layer of protection to the gear you need the most. This lid ensures that the gear you need stays dry, regardless of what brings you to the backcountry.

KEY FEATURES:

- 1 Heavy-duty reinforced zip pull tabs
- 2 Removable adjustable accessory strap included
- 3 Butterfly hinge between pockets
- Attaches to any MF Guide-light MT or Terraframe pack

SPECS:

Weight: 0.33 kg (27.2 oz)
 Vol: 8 L (490 cu-in)
 Dims: 5" x 14.75" x 12.25"

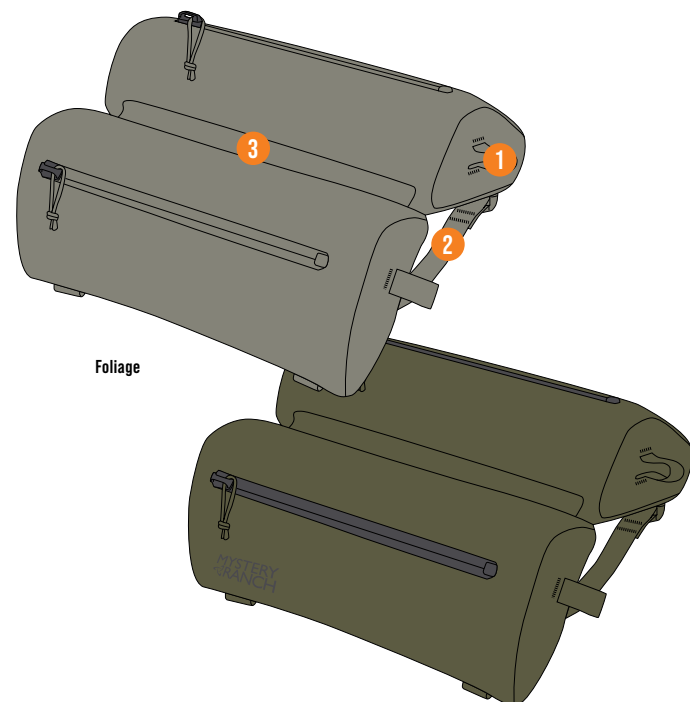

Foliage

Forest

ZOID CUBES

This cube set comes with three different sizes so you have just the right amount of storage for your next weekend getaway—whether you're traveling by plane, train, or automobile.

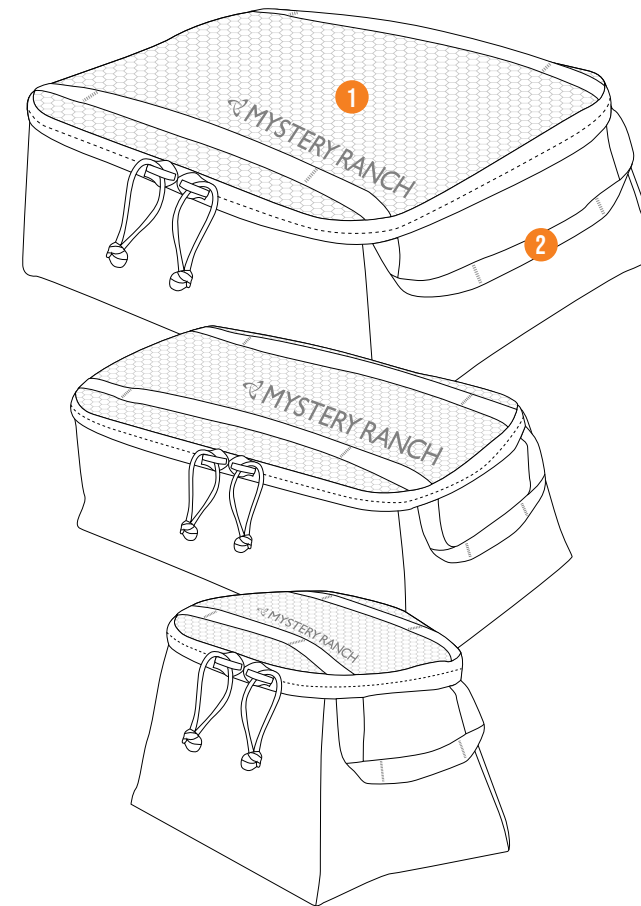

KEY FEATURES:

- 1 Monomesh lid provides visibility into the bag
- 2 Handles on sides and top for easy handling while packing/unpacking
- Designed to fit into the MYSTERY RANCH Mission Duffels, yet organizes any pack of choice.

SPECS:

LARGE

Weight: 0.11 kg (3.84 oz)
 Vol: 14.5 L (850 cu-in)
 Size: One Size

MEDIUM

Weight: 0.1 kg (3.52 oz)
 Vol: 8.3 L (505 cu-in)
 Size: One Size

SMALL

Weight: 0.06 kg (2.24 oz)
 Vol: 4 L (245 cu-in)
 Size: One Size

SET

ONE EACH: LARGE, MEDIUM, SMALL ZOID CUBE

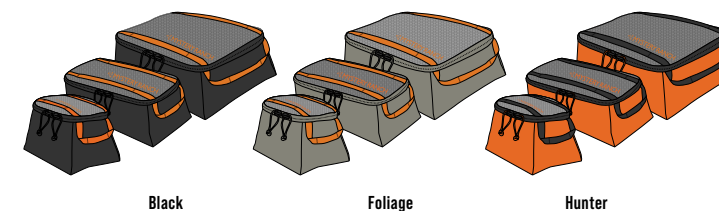

Black

Foliage

Hunter

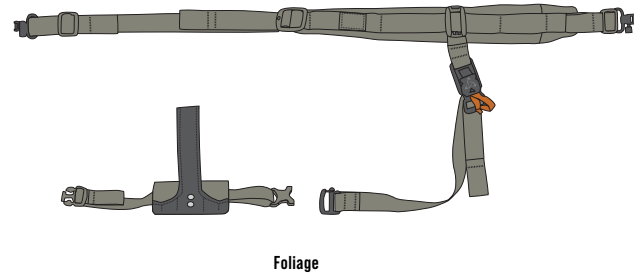

Foliage

HANDS-FREE RIFLE SLING

Weight: 0.27 kg (9.6 oz)

Size: One Size

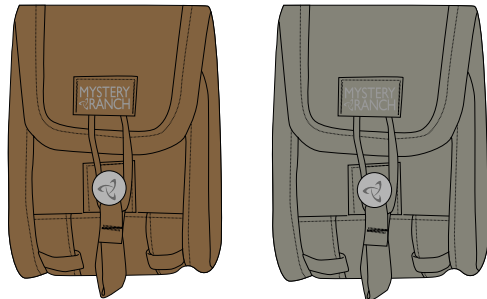

Coyote

Foliage

RANGEFINDER HOLSTER

Weight: 0.05 kg (1.6 oz)

Size: Fits most rangefinders

Dims: 5" x 3.5" x 1.5"

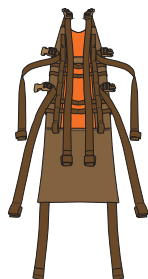

Coyote

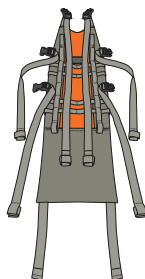

Foliage

BACKSTRAP

Weight: 0.28 kg (10 oz)

Size/Dims: One Size (29.5" x 8")



Black

Coyote

Foliage

DPM Camo

Hunter

TECH HOLSTER

Weight: 0.1 kg (3.2 oz)

Vol: Fits most phones

Dims: 7" x 4.5" x 2"

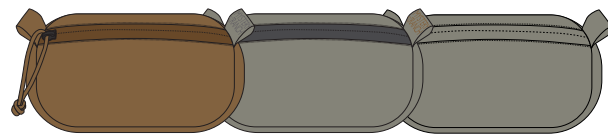

Coyote

Foliage

Shadow

FORAGER POCKET

Weight: 0.07 kg (2.5 oz) 0.08 kg (2.8 oz)

Vol: .75 L (46 cu-in) 1 L (61 cu-in)

Sizes: S

L

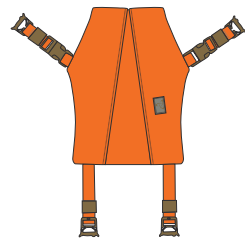

Blaze

BLAZE STICK IT

Weight: 0.2 kg (7 oz)

Size/Dims: One Size (15" x 10.5")

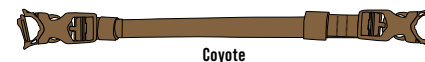

Coyote

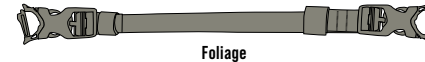

Foliage



Shadow

QUICK ATTACH ACCESSORY STRAPS

Weight: 0.06 kg (2.2 oz)

Size/Dims: One Size — 2 per pack (1" x 24")

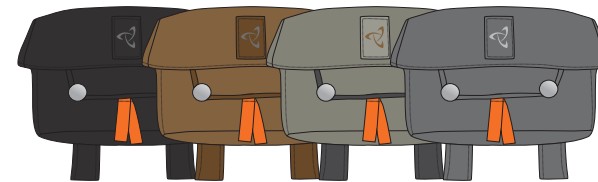

Black

Coyote

Foliage

Shadow

FORAGER BOX

Weight: 0.14 kg (5 oz)

Vol: 0.5 L (30 cu-in)

Size/Dims: One Size (5" x 7.3" x 3")



Black Orange



Shadow

PACK FLY

Weight: 0.09 kg (3 oz) 0.11 kg (3.7 oz) 0.15 kg (5 oz)

Vol: 25 L - 45 L 45 L - 70 L 70 L - 105 L

Sizes: S

M

L

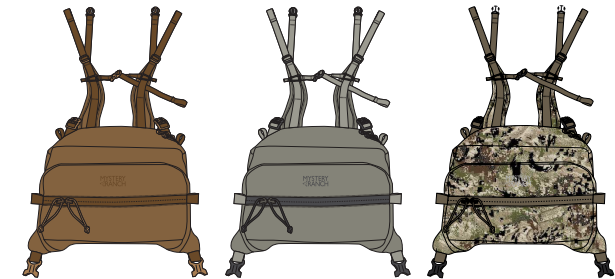

Coyote

Foliage

Subalpine

HUNTING DAYPACK LID

Weight: 0.37 kg (13 oz)

Vol: 11.5 L (700 cu-in)

Size/Dims: One size (6" x 13" x 11.5")

MISSION CONTROLS

When your mission is controlling all of your wires, chargers, and power banks, you need dedicated homes and easy access. The collection offers three different sizes to accommodate your organizational needs.



KEY FEATURES:

- 1 Ported zippered front pocket allows battery charging and easy access
- 2 Fully padded on all sides to dampen any drops
- 3 Soft webbing grab handle on top
 - Multiple porting options allow charging cables to run from the internal mesh pocket into the front pocket as well as the main bag
 - Two zippered inner mesh pockets, one divided to keep items organized

SPECS:

LARGE

Weight: 0.31 kg (10.9 oz)
Vol: 4 L (245 cu-in)
Dims: One Size

MEDIUM

Weight: 0.26 kg (9.2 oz)
Vol: 2.5 L (155 cu-in)
Dims: One Size

SMALL

Weight: 0.13 kg (4.5 oz)
Vol: 1.5 L (90 cu-in)
Dims: One Size



SPIFF KITS

From dorm rooms and go bags to truck campers and hotel suites, our SPIFF KITS keep you organized and looking spiffy no matter where you're going.

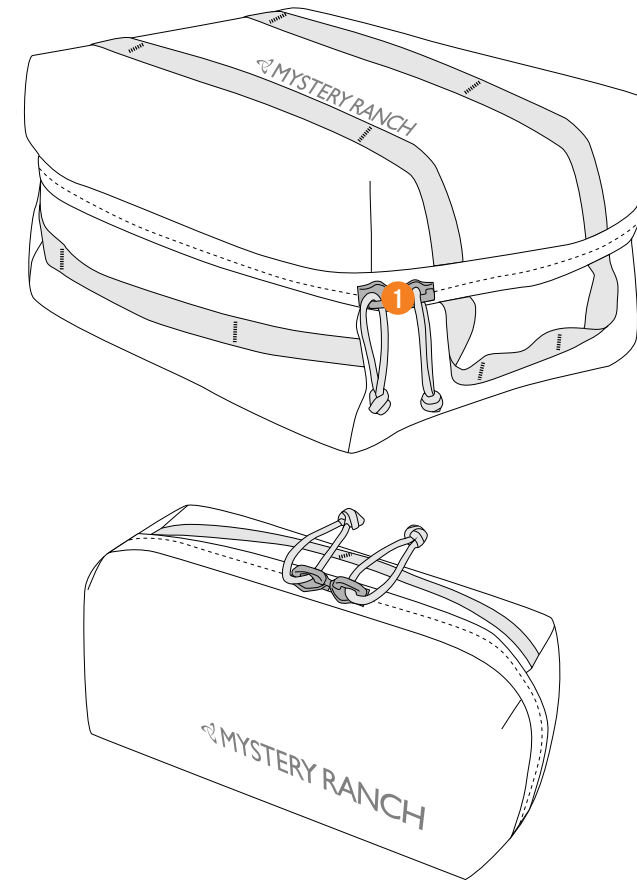

KEY FEATURES:

- 1 Divided zippered pockets with layered internal division and an elastic loop
 - Internal mesh pockets for organization
 - Fully lined for easy cleanup

SPECS:

LARGE

Weight: 0.3 kg (10.72 oz)
Vol: 6.3 L (385 cu-in)
Size: One Size

SMALL

Weight: 0.13 kg (4.64 oz)
Vol: 2 L (120 cu-in)
Size: One Size

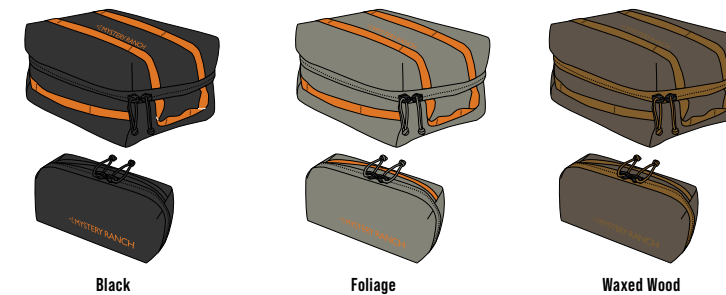

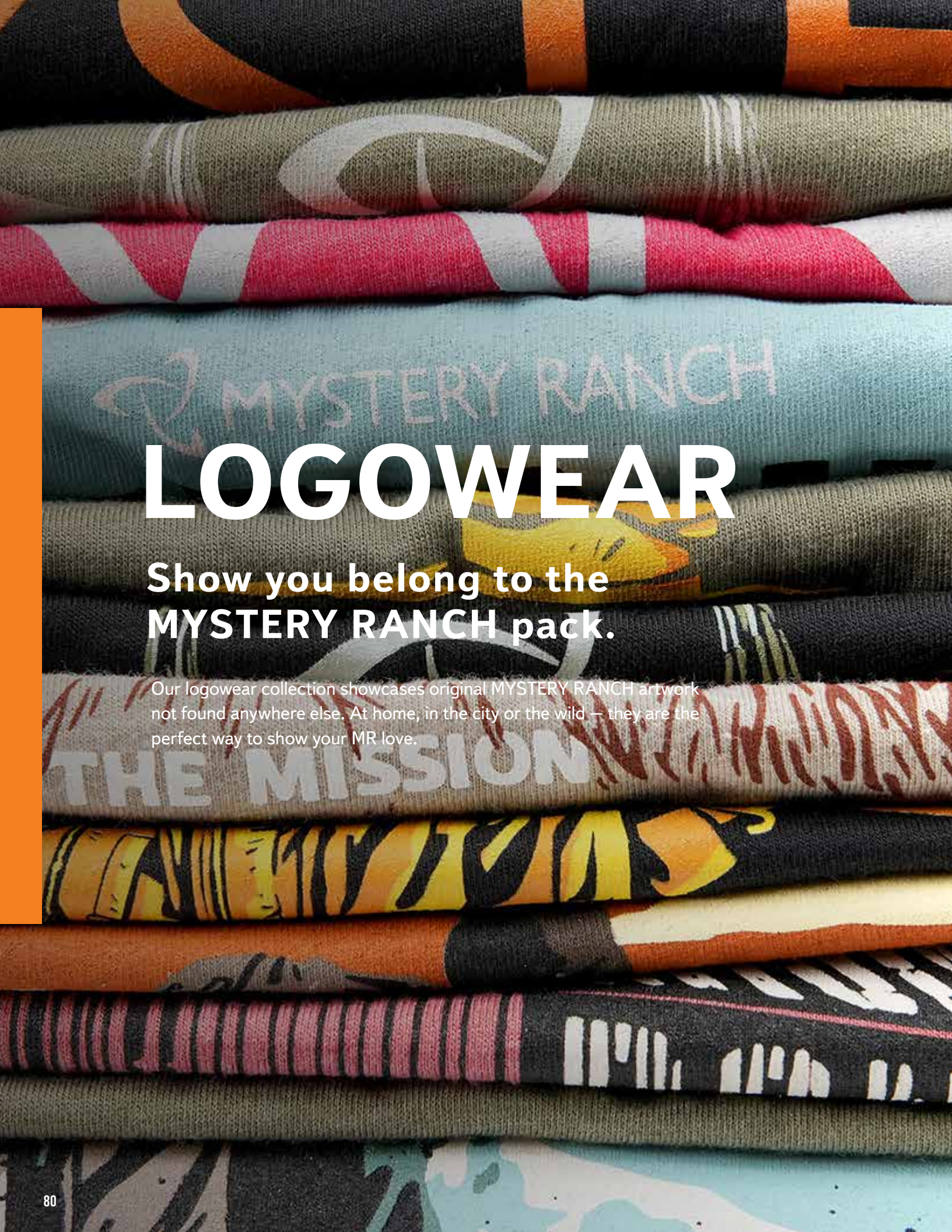

LOGOWEAR

Show you belong to the MYSTERY RANCH pack.

Our logowear collection showcases original MYSTERY RANCH artwork not found anywhere else. At home, in the city or the wild — they are the perfect way to show your MR love.



BACKPACK WORLD PATCH

Size: One Size



DEAD BIRD PATCH

Size: One Size



I WANT TO BELIEVE PATCH

Size: One Size



SAY YES TO PIZZA PATCH

Size: One Size



DOUBLE STUFF PATCH

Size: One Size



Navy

TAKE A HIKE HOODIE

Size: S M L XL XXL



Grey

CHEF'S CHOICE HOODIE

Size: S M L XL XXL



White

CHEF'S CHOICE

Size: S M L XL XXL



Black

Military Heather

EURO MOUNT MYSTERY

Size: S M L XL XXL



Wood

GOAT GRADIENT HAT

Size: One size



Black

Crimson

Military Heather

White

MR LOGO

Size: S M L XL XXL



Oatmeal Heather

Red Clay Heather

MYSTERY BARN

Size: S M L XL XXL



Shadow

MOOSE GRADIENT HAT

Size: One size



Black

Blaze Orange

Forest

HUNTER HAT

Size: One size



Black

Military Heather

PACK LIGHT

Size: S M L XL XXL



Navy

Oatmeal Heather

TAKE A HIKE

Size: S M L XL XXL



DPM Camo

WAGON HAT

Size: One size



Shadow

RANCHER BEANIE

Size: One size

FITTING & SIZING

The key to a comfortable pack load is a properly fitting backpack. We've designed our packs to have a more custom fit with simple sizing based off of two measurements.

Backpack Fitting

GETTING YOUR SIZE

To find the appropriate size waist and yoke for your pack, collect the following two measurements, then reference the sizing chart below.

1 Waist Circumference

Measure around your waist just above the top of your hip bones (roughly two fingers below your belly button).

2 Torso Length

Use a tailor's tape measurer or string and have a friend measure between the bony bump at the base of your neck (C7 vertebra) to the spot on your spine that is just behind your belly button.

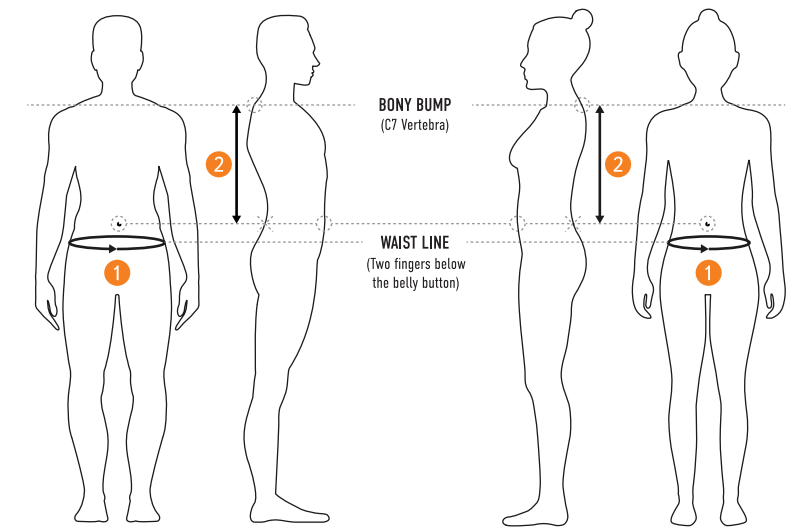

Men's Sizing

S		M		L		XL	
Torso	Waist	Torso	Waist	Torso	Waist	Torso	Waist
S/M	XS/S	S/M	S/M	L/XL	M/L	L/XL	L/XL
15 - 20 in	26 - 32 in	15 - 20 in	31 - 36 in	17 - 24 in	35 - 40 in	17 - 24 in	39+ in
38 - 51 cm	66 - 81 cm	38 - 51 cm	79 - 92 cm	43 - 61 cm	89 - 102 cm	43 - 61 cm	100+ cm

Women's Sizing

XS		S		M		L	
Torso	Waist	Torso	Waist	Torso	Waist	Torso	Waist
XS/S	XS/S	XS/S	S/M	M/L	M/L	M/L	L/XL
13 - 18 in	26 - 32 in	13 - 18 in	31 - 36 in	16 - 22 in	35 - 40 in	16 - 22 in	39+ in
33 - 46 cm	66 - 81 cm	33 - 46 cm	79 - 92 cm	41 - 56 cm	89 - 102 cm	41 - 56 cm	100+ cm

Limited Sizing

MEN'S S/M		MEN'S L/XL		WOMEN'S XS/S		WOMEN'S M/L	
Torso	Waist	Torso	Waist	Torso	Waist	Torso	Waist
S/M	Limited SMALL	L/XL	Limited LARGE	XS/S	Limited SMALL	M/L	Limited LARGE
15 - 20 in	26 - 36 in	17 - 24 in	35 - 50 in	13 - 18 in	26 - 36 in	16 - 22 in	35 - 50 in
38 - 51 cm	76 - 92 cm	43 - 61 cm	89 - 127 cm	33 - 46 cm	76 - 92 cm	41 - 56 cm	89 - 127 cm

One Size Fits Most

MEN'S		WOMEN'S	
Torso	Waist	Torso	Waist
S/M	One Size (O/S)	M/L	One Size (O/S)
15 - 20 in	30 - 40 in	16 - 22 in	30 - 40 in
38 - 51 cm	76 - 102 cm	41 - 56 cm	76 - 102 cm



MYSTERY RANCH BACKPACKS

1750 Evergreen Drive
Bozeman, MT 59715
833-548-1999

mysteryranch.com



COPYRIGHT © MYSTERY RANCH LTD 2023